

AUSTRALIAN
SCIENCE
TEACHERS
ASSOCIATION



INVESTIGATING SCIENCE IN THE BUSH

A Resource Book of ideas for National Science Week 2002

SASTA

South Australian Science Teachers Assoc.



Representing Science Teachers
of South Australia for 50 years

Ph: 08 8224 0871; Fax: 08 8224 0805;
Address: 1st Floor, 211 Flinders Street,
Adelaide, S.A., 5000
Email: office@sasta.asn.au

Science Teachers' Association of QLD



Promoting Excellence in
Science Education

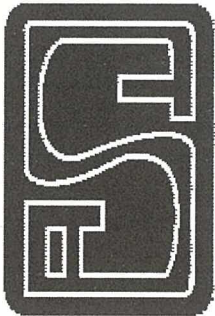

STANSW

Science Teachers'
Association of
New South Wales

Providing
leadership and
promoting
excellence in
science education



SCIENCE EDUCATORS ASSOCIATION OF THE ACT

Promoting Excellence in the
Teaching of Science

Science Teachers' Association of WA

Providing
leadership in
Science Education

www.stawa.asn.au



SCIENCE TEACHERS' ASSOCIATION OF TASMANIA

STAT



PROMOTING OUR PROFESSION
ENRICHING SCIENCE TEACHING



Founded 1943

STAV

Science Teachers' Association
of Victoria

ADVANCING SCIENCE EDUCATION

5 Munro St, Coburg Vic 3058 Mail: P.O Box 109, Coburg Vic 3058
Phone: 03 9385 3999 Fax: 03 9386 6722
Email: stav@stav.vic.edu.au Website: www.stav.vic.edu.au

Science Teachers'
Association of
the Northern
Territory



Promoting our profession:
enriching science teaching

Foreword

A resource book for National Science Week 2002

Investigating Science in the Bush is a resource book of activities and information, designed for teachers and students, and provides a range of interesting and exciting activities for use at school and at home. The book can be used throughout the year and should also assist you in planning for National Science Week, which will be held in August in 2002.

National Science Week, supported by the Commonwealth Government is a partnership program between the Australian Broadcasting Corporation, the Australian Science Festival Limited, the Australian Science Teachers Association and the Department of Education, Science and Training. National Science Week helps to focus community attention on science and its importance in the school curriculum and promotes the image of science.

The ideas and suggestions in this book are written for students from K to 12. Some you may find too difficult for your students and others may not be advanced enough. They are there to trigger your own ideas.

Each State and Territory has an ASTA National Science Week Coordinator. There is also a National Science Week Coordinating Committee in each State and Territory. Contact details are below.

National Science Week is one of many programs that ASTA organises to enrich school science education for students and teachers in primary and secondary schools. Please contact the ASTA office or your State/Territory Science Teachers Association for further information. A free copy of this resource book is one of the many benefits of membership.

ASTA is pleased to have received funding for this project from the Department of Education, Science and Training. ASTA Council thanks and congratulates the authors and designers of *Investigating Science in the Bush*, the National Science Week Coordinators in each State/Territory of Australia and all the teachers and students who become involved in activities during National Science Week.

We have included a questionnaire at the back of this book to gauge its value to teachers. Please take a few minutes to complete and return it and be in the draw for a wonderful prize.



Peter Russo
President

ASTA Secretariat
Australian Science Teachers Association
P.O. Box 334
Deakin West ACT 2600

Ph: 02 6282 9377 Fax: 02 6282 9477
Email: asta@asta.edu.au
Website: www.asta.edu.au

State/Territory Science Teacher Associations

ACT
SEA*ACT
GPO Box 1205
Canberra ACT 2601
Ph: (02) 6205 6344

South Australia
SASTA
1st Floor, 211 Flinders Street
Adelaide SA 5000
Ph: (08) 8224 0871

NSW
STANSW
C/- PO Homebush West
Homebush NSW 2140
Ph: (02) 9746 3210

Victoria
STAV
PO Box 109
Coburg Vic 3058
Ph: (03) 9385 3999

Northern Territory
STANT
PO Box 1168
Nightcliff NT 0814
Ph: (08) 8941 2699

Tasmania
STAT
Launceston Delivery Centre
Launceston TAS 7250
Ph: (03) 6233 5677

Queensland
STAQ, C/- School MSTE
QUT Kelvin Grove Campus
Victoria Park Road
Kelvin Grove, Qld 4059
Ph: (07) 3864 3340

Western Australia
STAWA
P O Box 1099
Osborne Park WA 6919
Ph: (08) 9244 1987

Contents

Foreword	1
Introduction	3
Bush Survivors	4
Bush Technology	13
Bush Living	23
Bush Ecology	28



AUSTRALIAN
SCIENCE
TEACHERS
ASSOCIATION



2002 Year of the Outback®



Publisher: Australian Science Teachers Association
PO Box 334 Deakin West ACT 2600

Author: Bob Winters, Gould League



Scientific and Indigenous culture authorisation:
Dr Adrian Daniell, Koori Education Development Unit, DEET and Bruce Gangell
Graphic design: Graphic Partners
Front cover: Trish Hart – designer, Nick Sandalis and Bob Winters – photographers
Illustrator: Sharon Madder

Winters, Bob
Investigating Science in the Bush
ISBN: 0-9586618-9-8

ASTA acknowledges the following for their valuable input during the drafting of this book:
Rhonda Charles, Ivan Coffin, Marj Colvill, Fred Deshon, Denise Devitt, Andrew Dodson, Jan Elliot,
Bruce Gangell, Rosalyn Gardiner, Jim Grant, Michelle Griffen, Lesley Hagen, Sally Hodgson,
Kathy Johnston, Ruth Learner, Lynn Murray, Yvonne Palmer, Jill Reade, Peter Russo, Lisa Scarfe,
Geoff Quinton, Sophie Tsiatsias, Judy Thorn and Joanne Witte.

Safety warning: All student activities included in Investigating Science in the Bush have been designed to minimise hazards. However, there is no guarantee expressed or implied that an activity or procedure will not cause injury. Teachers selecting an activity should test it with their own materials before using it in class and consider the occupational health and safety requirements within their State or Territory. Where physical activity is involved, the teacher should be qualified to conduct that activity.

Any necessary safety precautions should be clearly outlined by the teacher before starting the activity. Students must also be provided with any safety equipment prior to commencement.

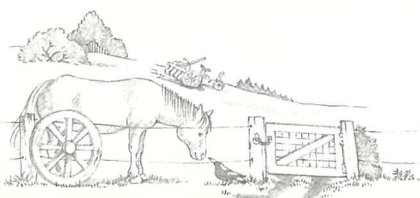

Introduction

Investigating Science in the Bush is aimed at engaging students in hands-on science. The bush in this publication refers to native forests, rural farmland, local parks and inland Australia. The activities are designed to provide students with scientific questions and technological challenges that can be investigated and explored.

Australians identify with the bush. It's a fascinating environment adapted to surviving drought and fire, with creatures and plants that are distinctly Australian. Australia's indigenous inhabitants have occupied this continent for tens of thousands of years. They have acquired an intricate knowledge of the bush and its wildlife. They know the seasons and have a great understanding of the land. Their knowledge, skills and technology enabled them to obtain water, food, medicine, fire and materials for making tools. European settlers using their Northern Hemisphere technologies struggled to survive in the bush. They were confronted with new problems and the more creative settlers succeeded in discovering and inventing solutions.

This book is also a celebration of the people who have used science and technology to enhance living and working in the bush, on farms and in remote areas. The bush is part of every Australians' heritage whether they live in a city, on a farm, along the coast or in the vast deserts. Students can also join in the Australian tradition and become bush inventors.

For city and country schools

Science in the bush is an excellent topic to fascinate all students. Even in the inner suburban areas, students have access to local parks, urban farms and waterways. Many of the themes covered in this book provide a stimulating introduction to a school camp in a rural area. Students will be able to complete many of the activities at the camp. Many city students, who visit the bush and rural areas with their families, will have a wealth of prior knowledge. Rural students will learn to apply scientific skills to living in the bush.

Bush units

Investigating Science in the Bush has been divided into four units:

Bush Survivors – Students investigate how plants, animals and people survive in the bush.

Bush Technology – Students investigate the use of science and technology in solving bush and rural problems.

Bush Living – Students investigate how people live in the bush and rural environments.

Bush Ecology – Students investigate a variety of current ecological issues in the bush.

This book covers a wide range of materials and teachers may want to select those areas most relevant and of greatest interest to their students.

Organisation of themes

Each unit has a number of themes or activities. Each theme with one exception has the following headings:

The science: describes the significant scientific background information for the theme.

The impact: describes the relevance and application of the science to people and the environment. Internet references at the end of this section are suitable as student references.

! Risk assessment: highlights when students should take extra care of safety aspects. Teachers selecting an activity should test it with their own materials before using it in class and consider the occupational health and safety requirements within their State or Territory.

The challenge: provides students with five or more progressively difficult challenges to investigate. Teachers should decide which of the challenges are applicable to their class and provide students with a choice.

Extra information: provides teachers with some initial ideas for completing one or more of the challenges. However, it is up to the students to devise their investigations. Some of the illustrations also provide ideas assisting in the development of investigations.

Any activity related to Indigenous learning should involve contact with the local Aboriginal or Torres Strait Islander community, Indigenous Education Officers or State Aboriginal Education Unit.

Class organisation

The challenges can be undertaken by groups of students. Some experiments are best done with close adult supervision or performed by the teacher as a class demonstration. It is anticipated that students will be provided with some choices about which challenges they do.

Prior learning

By providing students with stimulating prior learning activities, teachers will gain an understanding of their students' knowledge and students will be able to express and share their knowledge.

One popular method for prior learning is concept mapping. This activity is done as a class. The major theme or concept is written on a board, overhead, etc. Students contribute their knowledge, ideas and issues to a large diagram. All their contributions and ideas are linked using lines.

Students can be asked to present their ideas about a theme either individually or as part of a group. They can present their ideas in a range of ways:

- Write a story
- Write a letter home
- Write an email
- Create a web page
- Make an audio tape
- Present a postcard
- Create a series of pictures or paintings
- Write a newspaper story
- Design a poster
- Draw a cartoon
- Create a drama
- Write a poem
- Create a Powerpoint presentation

Students can be provided with a more direct task before they embark on a theme:

- Write about an ordeal concerning survival in the bush. Explain what the problem was and how it was solved.
- Write about the way Indigenous people live in the bush. Ensure students follow up their ideas by exploring a wide range of reference material.
- Make an illustration, painting, collage or 3D model of a farmyard or the ideal camping site.
- Make a list of things you would take if you were camping in the bush for five days with two friends (no electricity). The things must fit into the boot of a medium size car.

Homework

There are many opportunities for students to complete some of the challenges at home. Students can also ask their parents, guardians, grandparents or older people about their experiences in the bush and rural areas.

Assessment

Teachers can assess students' work as they complete their challenges. At the completion of this book teachers may wish to evaluate what their students have gained. The evaluation projects below or similar challenges will enable students to bring together what they have learnt.

Evaluation projects

Students can demonstrate what they have learnt by completing a project such as the following:

1. Construct a model of the farm of the future or a future national park visitor centre and describe its features.
2. Describe the future communication equipment needs to operate the farm or rescue people from the bush.
3. Compare the farm of today with a farm of the future.
4. Design an ecotourist adventure for a sensitive area that will not harm the environment. Explain how this can be achieved.
5. Design the national park of the future and explain how its biodiversity is protected.
6. Develop guidelines for farmers to protect the biodiversity on their land.
7. Develop a presentation that describes aspects of Aboriginal land use using posters, charts, videos, etc.



Bush Survivors

Introduction to Bush Survivors

The bush was home to Australia's indigenous cultures for tens of thousands of years. Their intimate knowledge of the environment was passed down from generation to generation through a rich cultural tradition. They acquired all their needs from the land, including water, food, medicine, firewood, clothing and raw materials to make tools and ceremonial costumes. Their lifestyle proved to be sustainable over many thousands of years.

In contrast, the first European settlers struggled to survive. They had no knowledge of the Australian environment and their European technologies did not work as well in Australia, and required major modification. Clearing the bush for farms was a formidable task. The soils and climates were markedly different from what they had known, many agricultural activities required additional effort. Isolation meant that sickness or injury was more life threatening. Disasters like drought and bushfires were additional dangers. For these people survival was a constant challenge.

People today still face situations where survival skills are very important. Their car might break down on a remote road, they can get lost in the bush or a threatening bushfire can confront them. Like the Aboriginal people, if all Australians have knowledge about their environment they are less likely to find themselves distressed in the bush or other remote areas.

Plants and animals have had millions of years to adapt to Australia's many and varied environments. They also need to survive local conditions.

The themes:

Evaporation and desiccation
Surviving the heat
Weather
Four-wheel drives
Salinity

Bush cooking
Bush refrigeration
Bush cleaning
Volunteer fire brigade
Aboriginal knowledge

Evaporation and desiccation

The science

All living organisms require water. The plants and animals that live in dry and hot environments have adaptations to overcome the scarcity of water. Some of the adaptations found in plants include:

- ability to store water
- leaves with hairy and or waxy surfaces, grey colouring
- absence of leaves or modified leaves like the acacia's phyllodes
- ability to become dormant
- seeds in the soil ready to germinate after rain
- very deep roots
- small leaves to minimise the surface area.

Adaptations found in animals include:

- remaining inactive during the hot day or sleeping in a burrow
- ability to cover large distances to reach a water hole, e.g. kangaroos, pigeons and parrots
- breeding after heavy rains
- seasonal migration to cooler environments
- losing body heat by increasing the surface area, e.g. kangaroo's large ears
- mechanisms to conserve water
- eating food that contains most of the animal's water requirements.

Humans have no special adaptations to survive in hot dry environments with minimal consumption of water. They must have a constant supply of water to remain alive.

Discover how the water cycle recycles water:

www.wrc.wa.gov.au/schools/water_cycle.html

www.citywestwater.com.au/environment/water_cycle.htm

Inspect water filter products: www.crystalline.com.au

The impact

Having access to constant clean water has always been a significant survival issue in the Australian bush and outback. The Aboriginal people had an intimate knowledge of the environment and how to access the available water. When there was no surface water they discovered where to dig and which plants had a store of water.

Today in Australia, most people are connected to a water supply. Those who aren't usually collect rainwater from their roofs and store the water in large tanks. Farm dams and bores are the most common method for providing stock with water. These dams and bores have become a significant source of water for many mobile animals like kangaroos, parrots and pigeons.

⚠ Risk assessment

Ask students to present their designs of experiments and activities for "Risk assessment". Instruct students about modifications, provide appropriate instruction, safety equipment and supervision. When necessary do the experiment or activity as a teacher demonstration or abandon it altogether.

The challenge

Students can investigate the effects of evaporation and desiccation by completing a challenge:

1. Find out how people lose water from their bodies and present the data in a chart or PowerPoint presentation.
2. Discover and describe which characteristics of plants and animals best assist survival in dry conditions.

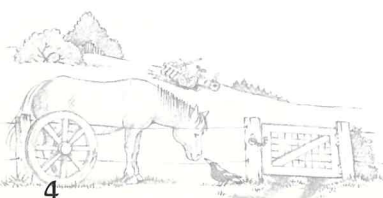
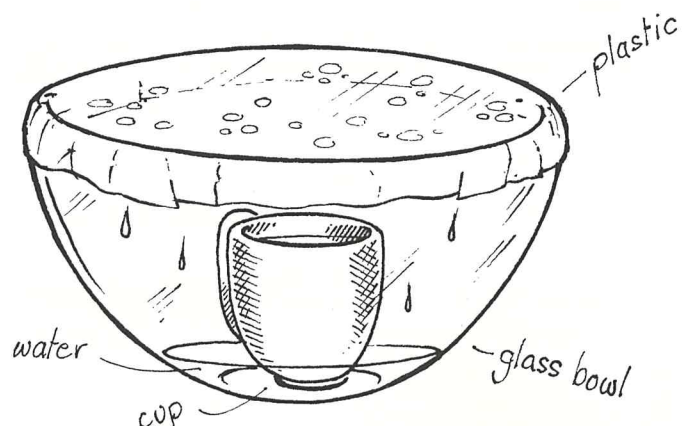

Bush Survivors



3. Explain how Aboriginal people are able to find water in dry environments like the bush.
4. Plan an investigation to measure how much water a potted plant loses each day.
5. Design a chart and carry out measurements to record all the water personally consumed in a day. Comment on the results. (This activity can be extended to the student's family.)
6. Design an investigation to compare water loss from plants on hot and colder days or water loss in different types of plants.
7. Design a process to keep a potted plant alive with no additional watering for a month from the time it is setup.
8. Devise a method to make clean water from dirty water. (Do not drink the water.) Can a water filter be made from gravel and sand? Present a report on the findings.
9. Discuss and recommend solutions to protect the water supply from pollution.

Extra information

- Students may like to experiment with different methods for measuring water loss from a plant. They can weigh the potted plant at the beginning and end of the day. They can measure the amount of water placed on the plant, making sure that water is not lost from the bottom of the pot or evaporated from the soil.
- They can enclose a bunch of leaves on a living plant in a plastic bag and measure the amount of water it accumulates in the bag.
- Visit a local water authority and find out how the town/city water is cleaned.

Surviving the heat

The science

The human body is able to maintain a constant body temperature. The body increases its metabolic rate when it's cold. Food and oxygen are metabolised faster to release heat, carbon dioxide and water. When it is hot, the evaporation of sweat removes heat from the body due to the cooling effect of evaporating water.

Dataloggers are electronic devices that can make continuous records. The records can be stored and easily graphed. Dataloggers are useful for measuring change and rate of change. However depending on the dataloggers construction, dataloggers are ideal for recording changes in temperature. They can also measure other variables like light. The information is in a graphical format that assists the analysis of the data.

Learn about different types of thermometers on the Internet:

<http://unidata.ucar.edu/staff/blynds/tmp.html>

Find out more about dataloggers: www.tain.com.au

The impact

The body temperature of humans is normally 37 degrees Celsius. Under hot conditions the rate of sweating increases. Under extremely hot conditions, if the body can't cool itself through sweating, the body temperature rises. If the body temperature rises by a lot brain damage can occur. Small children and dehydrated people are most vulnerable.

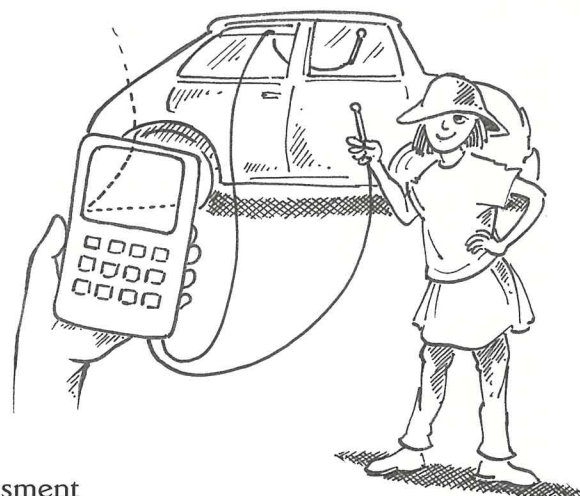

⚠ Risk assessment

Ask students to present their designs of experiments and activities for "Risk assessment". Instruct students about modifications, provide appropriate instruction, safety equipment and supervision. When necessary do the experiment or activity as a teacher demonstration or abandon it altogether.

The challenge

Students can investigate the implications of surviving hot, dry conditions, by completing a challenge:

1. Make a list of things that are needed for survival when travelling across the Simpson Desert for 3 days by foot, camel or car. Explain why these things are needed.
2. At a specific time, discover the hottest and coldest location in the classroom and/or school ground. Predict the most comfortable location on a hot day to study or to chat with friends.
3. On a warm sunny day, examine how long it takes for a car in the full sun to reach a lethal temperature (about 50°C). Alternatively compare, using graphs, the change in temperature over a day between a car in the sun and one in the shade.
4. On a warm sunny day in the school ground, find out how shade trees affect the temperature. What type of trees make the best shade trees? Compare exposed areas with different densities of shade trees. Is there a variation in humidity?
5. Design a container to keep ice blocks frozen for the longest period. Compare the results with the class and identify features that improve the performance of insulation. Predict how long food would be safe to store in the ice container.
6. Design clothing to protect people from heat as well as hypothermia.

Extra information

In the challenges that require measurement, ask students to present their data in the most appropriate form, e.g. graphs. Introduce students to dataloggers or thermometers. If available, demonstrate how a wet and dry bulb thermometer can measure humidity. Students may need help to interpret the conversion chart (i.e. the difference in temperature between the wet and dry bulb) to identify the percentage humidity.



Bush Survivors

Weather

The science

The weather changes constantly as masses of air move around the globe. Daily weather is influenced by a range of variables that include:

- seasonal influences due to the rotation and tilt of the Earth around the Sun
- the amount of radiant energy reaching the ground
- cloud cover and the types of cloud
- wind direction and wind speeds close to the ground and higher in the atmosphere
- moisture in the air
- sea temperature
- the variation in air pressure
- the altitude of the location.

In Australia, the Bureau of Meteorology collects and analyses information from many different sources so the weather can be predicted. Meteorologists have powerful computers programmed with complicated mathematical models. Updated information is constantly fed into the computer so that weather predictions can be provided for most of Australia. An important aspect of this work is to predict dramatic weather events like storms and provide warnings.

Weather constantly fluctuates and so it is difficult to identify whether the climate is changing due to greenhouse gases or whether the changes observed are within normal climatic variations. On a global scale, for the past decade, there have been higher than normal temperatures. This might indicate climate change.

The meaning scientists apply to weather is different to the meaning applied to climate. Weather refers to the day-to-day fluctuations in temperature, rainfall, humidity, wind, cloud cover, snow, lightening storms, etc. Climate refers to the long-term average trends over a number of years.

The Bureau of Meteorology, provides a check on the weather, satellites and education materials: www.bom.gov.au
Look at the weather forecast on: www.ninemsn.com.au
Links to weather, climate and related topics:
www.csu.edu.au/weather

Interact with other schools by joining Project Atmosphere Australia Online: www.schools.ash.org.au/paa/paa.htm
Contact Bureau of Meteorology, Public Affairs on (03) 9669 4564 for pamphlets on interpreting satellite images, climate variability, UV forecasts and recognising cloud types.
Colls & Whitaker, 2001, *The Australian Weather Book* published by Reed New Holland
Every Drop Counts Primary and *Every Drop Counts Secondary* published by the Gould League, 2000.

The impact

Storms, lightning, drought, hail, floods, cyclones are some of the weather conditions that can affect people who live in the bush or use the bush for recreation. Farmers are affected by weather when they don't receive the rain they need, get too much rain or receive unexpected frost. Animals and plants have evolved so that they recover after severe weather conditions. Some of the changes made by people to the bush can make the conditions worse. For instance, clearing of trees can increase the amount of water runoff and increase the impact of floods and overgrazing can lead to dust storms during severe winds. Scientists are making enormous efforts to refine weather and climate models so the impact of the greenhouse gases can be predicted.

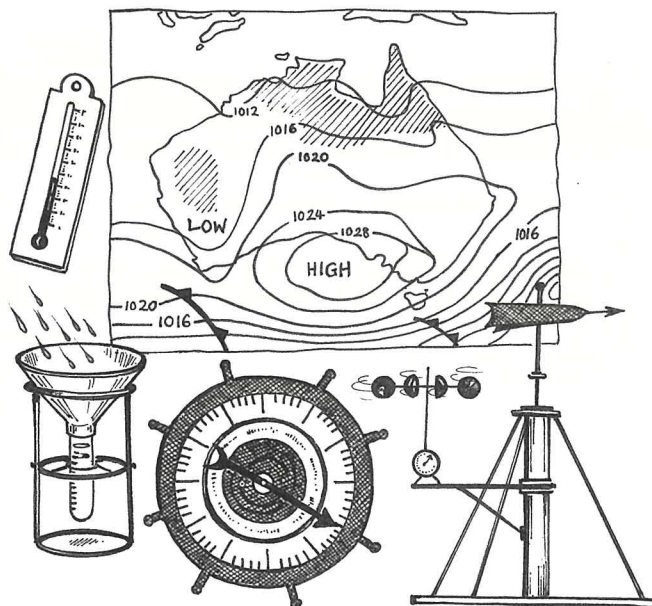

⚠ Risk assessment

Ask students to present their designs of experiments and activities for "Risk assessment". Instruct students about modifications, provide appropriate instruction, safety equipment and supervision. When necessary do the experiment or activity as a teacher demonstration or abandon it altogether.

The challenge

Students can investigate weather, weather forecasting or the greenhouse effect by completing a challenge:

1. Draw a concept map or poster to show how weather effects people in the local area.
2. Among the class, what is the preferred form of finding out about the weather forecast? E.g. TV, Internet, Radio, Newspapers. Which is the preferred Internet site? Why do students prefer some sites?
3. Record daily weather measurements using a barometer, rain gauge and thermometer. Place the information in tables. Describe the patterns and explain why they occur.
4. Take daily weather readings and compare these with daily weather reports. Discuss any differences. How reliable are the local weather forecasts?
5. Investigate the effects of different temperatures on the amount of water a plant requires.
6. For different locations around Australia, predict the most comfortable time to visit the bush as a visitor, farm worker or adventurer. Present the information in the form of a brochure, e.g. travel or adventure brochure, work safety brochure.
7. Predict the impact on the local environment, the bush and farms if greenhouse gases change the climate, e.g. hotter and drier, hotter and more rain or more violent storms. Discuss how the impact of greenhouse gases can be reduced.

Extra information

Explore how basic weather instruments work. These include thermometer, rain gauge, wet and dry bulb thermometer (measures percentage humidity), barometer (measures air pressure) and anemometer (wind gauge). Discuss how students can find out about the weather and what their preferred weather medium is. Newspaper weather reports and Internet weather printouts can be displayed in the class.

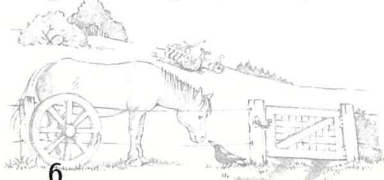

Bush Survivors

Four-wheel drives

The science

Four-wheel drives (4WD) are vehicles that can engage the motor to all four wheels. The engine is connected to a special gearbox. In manual 4WDs the gearbox has two gearshifts. There is a normal gear lever that changes gears through the normal four or five ratios. The second gear shift enables the normal gears to be used in a lower ratio. This results in the wheels moving slower and therefore the wheels apply more force to the ground and there is less chance of the wheels spinning. This second gear lever can also change the number of wheels engaged from two to all four. The gearbox is a complex series of shifting gears that is coupled to two drive shafts. One drive shaft goes to power the front wheels and the other to the rear wheels. These drive shafts power a differential that redirects the force to the wheels, while allowing the wheels to travel at different speeds, necessary for the vehicle to turn corners. This system enables 4WDs to drive in areas where ordinary cars might get bogged or damaged.

To enable 4WDs to travel over rough ground the chassis and floor pan must have a high clearance. A high clearance shifts the vehicle's centre of gravity to a higher point and thus the 4WD is more likely to roll on a steep incline.

See what enthusiastic 4WD owners do:

www.4x4abc.com and motorcare.com.au

Inspect a range of winches: www.pullpal.com

Look inside a differential:

www.4x4abc.com/4WD101/differential.html and

www.geocities.com/offroadvehicle/4wdwhatsthehdiff.html

The impact

Four-wheel drives (4WD) and tractors are among the important tools for modern farming. 4WDs are also important for transport throughout the bush enabling people to use rugged roads and to cross waterways. While 4WDs are designed for rugged terrain, they can topple over and cause fatal accidents in the bush. The skill and care of the driver is equally important to the engineering of the 4WD. In some bush locations the thoughtless driving of some 4WD owners is causing major environmental damage to small trees, shrubs, ground cover and animals. This type of activity is often illegal and people should remain on the defined tracks.

Risk assessment

Ask students to present their designs of experiments and activities for "Risk assessment". Instruct students about modifications, provide appropriate instruction, safety equipment and supervision. When necessary do the experiment or activity as a teacher demonstration or abandon it altogether.

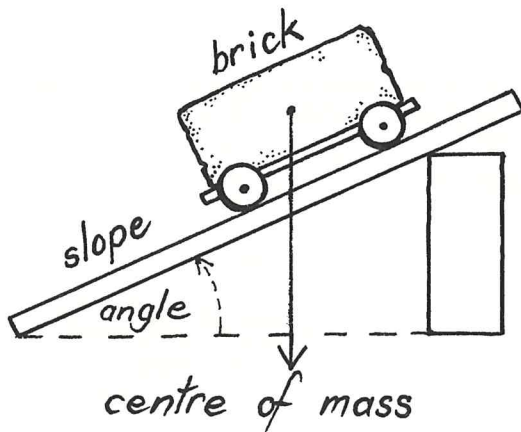

The challenge:

Students can investigate the transfer of forces and the centre of gravity of a 4WD by completing a challenge:

1. Use books or invite a guest speaker to informed students about how a 4WD operates.
2. Locate the major components on a 4WD including the engine, gearbox, differentials, driveshafts, hubs etc. How do the gearshifts operate?
3. A differential in a vehicle is used to change the direction of a rotating force. Construct cogs that perform the function of a differential.
4. Use weighted models to experiment with the influence of the centre of gravity on different angled slopes.
5. Design a mechanical device to drag a weight (simulated bogged 4WD) along a classroom floor. Describe and measure how the forces are transferred.
6. Develop a code of conduct for 4WD drivers to help prevent harm to the environment.

Extra information

To find out how stable a 4WD is on a slope students can experiment with a brick and a set of axles and wheels to simulate a 4WD. Two axles and wheels from a toy car can be taped onto the brick. The brick can be placed in three positions. It will be necessary to move the wheels along the axles or the centre of gravity will not change for some configurations. On a sloping board experiment at what angle the brick topples for different configurations. Ask students to identify the best configuration for a 4WD.

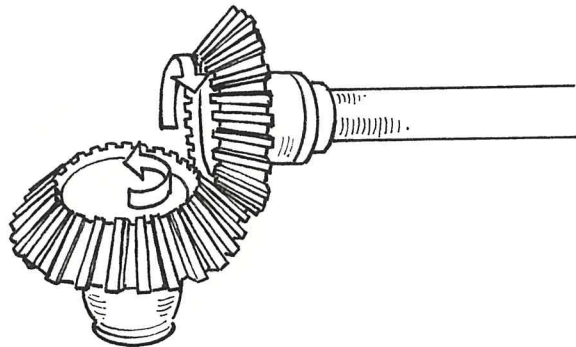
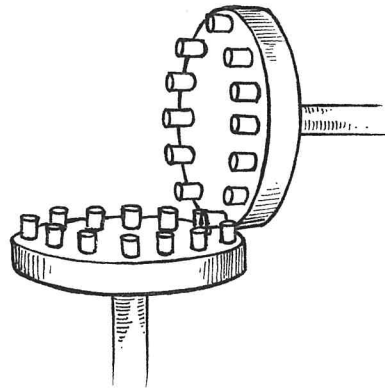

Bush Survivors

Salinity

The science

Salinity of drylands occurs when rising saline ground water reaches the surface of the soil or is discharged into lakes and streams. In large areas around Australia, salt has always been present in the watertable. Salt from the rocks has dissolved into the ground water. In the past, however, the ground water was at a much deeper level where it caused no harm.

In agricultural areas used for grazing, the grasses have shallower roots and use less water than the trees they replaced. Over time more water may be collected in the ground as the grasses use less water than trees. This allows the watertable to creep towards the surface bringing with it dissolved salts. Saline water starts killing crops and plants that aren't salt tolerant once it's within two metres of the surface. The watertable is not at an even depth and the saline ground water may reach the surface creating salt pans and contaminating lakes or streams. It is most likely to come to the surface on a valley floor or the side of a hill. Excessive use of irrigation water can also raise the watertable.

High concentrations of salt are harmful to life if organisms don't possess special adaptations to cope with it. Osmosis describes the movement of water across a barrier like a cell membrane. A cell membrane acts as if it has small holes. These 'holes' enable water molecules to pass through, but prevent salt ions from doing so. When there is a high salt concentration on one side of the membrane compared to the other, the water will move towards the high salt concentration until both sides of the membrane have equal concentrations of salt. This osmosis effect will prevent normal plants from obtaining water in saline soils.

Click on "links" to open up a web of resources: www.salinity.com.au
More about salinity: www.saltwatch.org.au and www.ndsp.gov.au
Latest ABC Landline investigations: abc.net.au/landline/default.htm

The impact

Once saline ground water has reached the surface, the plants die and the area of land affected becomes useless. Often the saline ground water has travelled from the slopes above some kilometres away. Presently 2.5 million hectares of land are affected costing agriculture billions of dollars, but if the problem is left unchecked, it could grow to 16 million hectares.

The exact cause and nature of the salinity problem will influence how local salinity problems can be halted and cured. Often appropriate tree planting in carefully chosen areas will draw water from the water table and reduce the salinity problem. These solutions take many years to reduce local salinity problems.

⚠ Risk assessment

Ask students to present their designs of experiments and activities for "Risk assessment". Instruct students about modifications, provide appropriate instruction, safety equipment and supervision. When necessary do the experiment or activity as a teacher demonstration or abandon it altogether.

The challenge

Students can investigate the effects of salinity by completing a challenge:

1. Find out how salinity affects agriculture.
2. Grow a salt crystal. As the crystal grows, present the results as a series of photographs or as a graph.
3. Evaporate given volumes of water from local waterways and measure the amount of material dissolved in it.
4. Use a water monitoring kit to measure the conductivity (approximate salt concentration) of the local creek.
5. Use different methods (weight, digital camera) to compare how salt effects slices of three different fruits. How does osmosis work? Predict what effect salt may have on growing plants.
6. Compare how the concentration of salt affects the germination of wheat. Use the same number of seeds in each experiment. Also grow seeds using pure water (control) and compare.
7. Debate the issues of salinity. What does it cost the country in lost production? How does the government help to fix the problem? How will rural communities be affected and what responsibilities should landowners have? What can people living in cities do to help?

Extra information

Many city and country schools can receive assistance from their local Waterwatch coordinator. Sometimes the local program may be called Streamwatch or Saltwatch. To find the local coordinator start by looking at www.waterwatch.org.au and click on "who to contact".

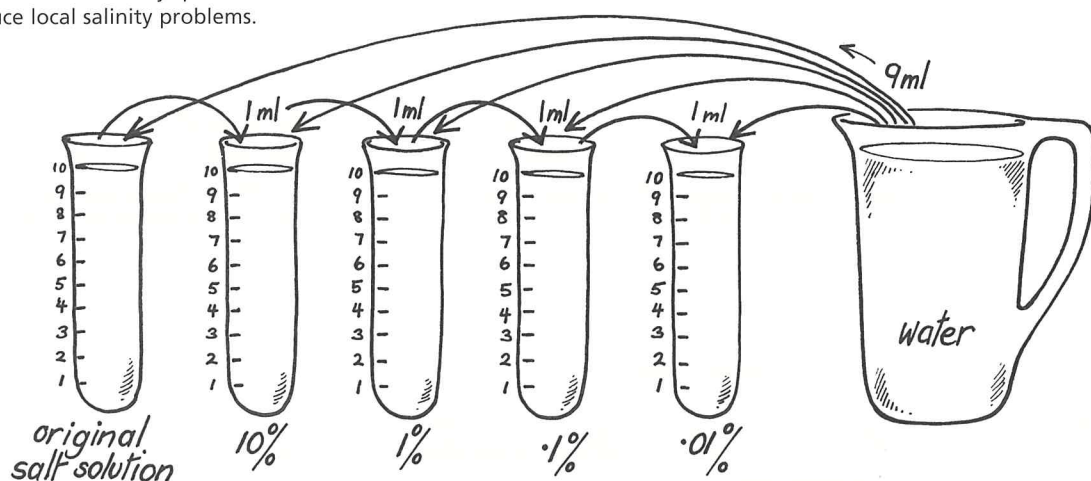

Bush Survivors

Bush cooking

The science

Humans have harnessed the use of fire for cooking food for thousands of years. When some foods are cooked, the body is better able to digest them. Cooking can kill most harmful bacteria and destroy many toxic chemicals in food. Many foods can be made more palatable by cooking, e.g. flour which is extracted from grass seeds can be baked into bread.

Cooking can be performed in a number of ways. Some foods can be cooked over naked flames. This is a fast process but it does not suit all food. Naked flames can deposit carbon over the surface of food. Hot coals or rocks heated in a fire can be used to cook food and not deposit carbon. Oven cooking is a more refined process that has more control over the heat. Boiling food became possible once saucepans became common. As well as these processes, some foods can be smoked when the appropriate timber is slowly burnt in a confined space or they can be dried in the sun. These processes can also preserve some food.

The most common cooking methods used by campers are the use of wood fires or portable gas stoves. For a wood fire, hot flames under a billy is the fastest way to boil water, but hot coals are better for cooking meat slowly. Gas stoves provide a more controllable source of heat. Liquid propane is stored under pressure in a metal gas tank. When the gas tap is turned on, the liquid turns into a very cold gas. The gas tank is connected to a gas appliance via a hose. A tiny hole in the gas jet or gas hose prevents all the gas spurting out at once. A small controlled stream of gas is fanned out through the slots of a round gas burner. A metal cooking utensil sitting over the flame will be efficiently heated. Trangia stoves that burn methylated spirits are used by bushwalkers. Methylated spirits is a safer fuel to carry than other types of liquid fuel.

Inspect some creative solar cooker inventions: <http://solarcooking.org>

The impact

People can have a major local impact when they use fire and firewood inappropriately. Removing fallen timber from the bush is starting to have a significant impact on these forests. It is removing animal homes and may be having an impact on the fungus and other soil organisms that keep soils in the bush healthy for trees and other plants. Campers must also be very careful and ensure they do not start bushfires and do not leave litter in the bush.

⚠ Risk assessment

Ask students to present their designs of experiments and activities for "Risk assessment". Instruct students about modifications, provide appropriate instruction, safety equipment and supervision. When necessary do the experiment or activity as a teacher demonstration or abandon it altogether.

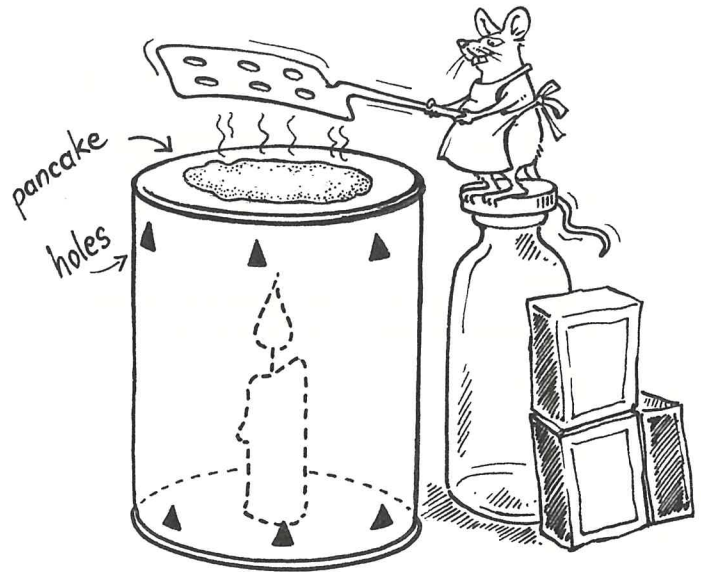

The challenge

Students can investigate methods for bush cooking by completing a challenge:

1. Plan the food for a five-day camping trip making sure all the essential food groups are included.
2. Using cold water or cold tea, find out whether "spinning the billy" produces any observable changes to the contents.
3. Cook bread/damper in a camp oven or cook a pancake using a tin can and candle. What factors improve the cooking process?
4. Investigate the burning times of different types of solid fuel. Design the experiment so there is only one variable. (Do not use liquid fuels.)
5. Make a solar cooker and test its effectiveness.
6. Design a campfire that is safe for people and the environment and uses minimal fuel.
7. Determine and justify safety recommendations that aim to prevent campfires from injuring people or causing bushfires.

Extra information

Why doesn't the water fall out of a spinning billy? Spinning is not like speeding in a straight line. To rotate in a circle requires acceleration. Acceleration is a force. The spinning force is maintained because the arm and hand is holding onto the billy. The water stays in the billy because the force of the accelerating, spinning billy is greater than the force of gravity. Letting go of the billy will initially allow it to move in a straight line (directly away from the arm) until the force of gravity changes its direction.



Bush Survivors

Bush refrigeration

The science

Keeping fresh food cold extends the time it can be used safely as cold temperatures reduces the growth of harmful bacteria. Before fridges, people purchased large ice blocks that were delivered to their homes and placed into insulated ice chests. The ice kept the chest cold until all the ice melted. Where ice was not available in the bush, people devised the coolgardie safe. This is a box or frame with flywire for panels and a hessian covering on the outside. The hessian is kept damp and as the water evaporates, the safe becomes cool. Only the fastest moving water molecules on the hessian evaporate, thus removing heat in the same way evaporating sweat keeps people cool. Coolgardie safes have the greatest impact in low humidity, when it is warm and there is air circulation. This form of cooling is not reliable enough to store fresh meat. Other strategies to preserve meat include salting or drying.

The impact

People without refrigeration can't keep meat and dairy products for extended periods of time. However, fresh food will remain safer if kept in cooler conditions. An "esky" and ice is like a small plastic insulated version of the old ice chest.

⚠ Risk assessment

Ask students to present their designs of experiments and activities for "Risk assessment". Instruct students about modifications, provide appropriate instruction, safety equipment and supervision. When necessary do the experiment or activity as a teacher demonstration or abandon it altogether.

The challenge

Students can investigate cooling and insulation by completing a challenge:

1. Describe how the Aboriginal way of life enabled them to live successfully without refrigeration. Find out how they planned and maintained a fresh supply of food.
2. What kind of ice (large blocks, party ice) is best to use in an "esky"? Investigate and compare the effect of many small ice blocks with the effect of a single large block. Measure and graph the melting of the ice.
3. What material makes the best ice chest? How does the thickness of materials affect insulation properties? Test a range of materials and their insulation properties to design the ultimate "esky". Present the findings in the form of an advertising brochure.
4. Construct a coolgardie safe and measure the temperature inside. Change some of its features (variables) to determine the set of variables that produces the coolest temperatures.

Extra information

To make a model of a coolgardie safe obtain some plastic icecream containers, scissors, hessian, thermometers, and a stone. Take an icecream container and cut out the side panels so it has a sturdy leg on each corner and looks a little like a table. Place the container on a flat surface so it stands like a table and place a thermometer inside/underneath. Place another icecream container right way up on top of the cutout container. Lay the piece of hessian over the containers so they are evenly covered. Place the stone on top of the hessian so it sinks into the top container. Make sure the hessian becomes damp. Place water into the top icecream container. Experiment with air circulation and other variables to identify the factors that produce the greatest cooling effect.

Bush cleaning

The science

The purpose of cleaning products is to:

- dissolve grease and other substances that don't dissolve in water
- kill germs
- be a harsh or gentle abrasive
- polish surfaces.

What did people do before the latest expensive cleaning products became available? Their homes were as clean as they are today. They used a range of common cheaper products that have less impact on the environment. The knowledge of how to use these products is still around in many family country homes. Vinegar, bicarbonate of soda, lemons, cooking salt, steel wool, olive oil and eucalyptus oil will clean most things around the home.

The impact

Using these simpler products is better because:

- fewer resources are required to produce them
- they are mostly derived from renewable resources
- there is less pollution created when these products are used in the home
- they will have less effect on those who have severe allergies to chemicals
- money is saved as they are cheaper.

Some examples of cleaning solutions and possible uses are:

- use lemon and salt to clean saucepans
- bi-carb soda and steel wool will make a sink shiny
- a mixture of half vinegar and olive oil left to dry on timber furniture for ten minutes and then rubbed will polish and protect a wooden surface.

Some of the soaps used in the past, however, had a greater impact on the environment than their current replacements.

⚠ Risk assessment

Ask students to present their designs of experiments and activities for "Risk assessment". Instruct students about modifications, provide appropriate instruction, safety equipment and supervision. When necessary do the experiment or activity as a teacher demonstration or abandon it altogether.

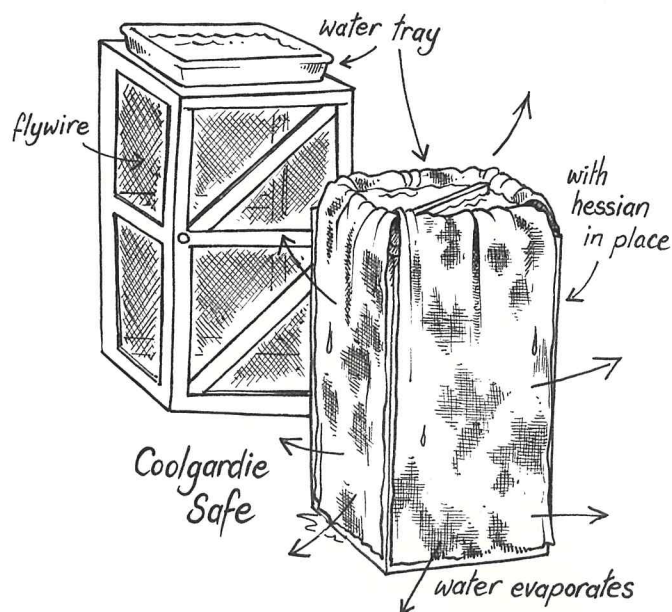

Bush Survivors

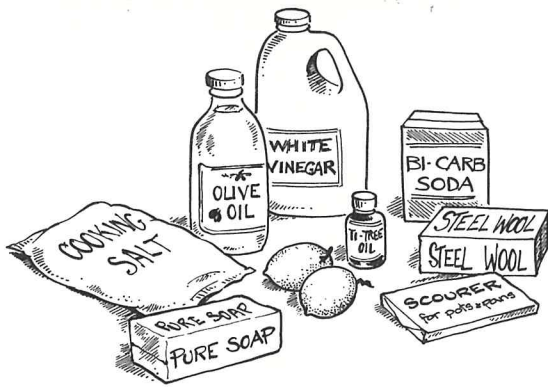

The challenge

Students can investigate bush cleaning products by completing a challenge:

1. Describe products that were once used for cleaning. Why have the products changed?
2. Make a poster or use PowerPoint to show how these alternative products can be used for cleaning.
3. Interview an older person about cleaning products used in the past. Ask them to explain the good and bad points. Present a report in a preferred format.
4. Experiment to find out how these alternative products can be used for cleaning. Which products dissolve grease, remove stains, clean metal and polish timber?
5. Design an experiment to compare supermarket products with alternative products.
6. Assess the environmental impact of modern cleaning products purchased in shops.

Extra information

To start students on this activity, provide some alternative cleaning products and set the students a task. The tasks might be deciding which combination of products best cleans the tops of desks, cleans the drinking troughs or cleans shoes. You may want students to wear old clothes. Students may like to clean their kitchens and kitchen utensils using the products already mentioned.

Volunteer fire brigade

The science

Fire needs = fuel + heat + oxygen (O₂)

For a bushfire to burn it requires suitable dry fuel, heat and oxygen. The role of the firefighter is to reduce one or all of the components of a fire. This can be achieved by cooling the fire and reducing the oxygen by spraying the fire with water. Low intensity ground fires can be smothered (reduction of O₂) using a fire broom (a broom handle with straps of hessian that are kept wet). To remove fuel, fire breaks can be created by clearing with bulldozers or lighting smaller fires to consume fuel in a controlled way.

Volunteer fire brigades need to be able to quickly detect fire outbreaks, gather their firefighters and dispatch them with the appropriate equipment in a coordinated way to fight the fire. It's important that the lives of the firefighters are not placed at risk. To achieve this, volunteer fire brigades have special communication equipment that can operate in rugged country. They are in constant contact with the coordinating fire station that can advise them about changing weather conditions.

Firefighters require special clothing to protect them from radiant heat. Helmets protect their heads. Their boots are suitable for standing on the hot ground. They also have access to breathing equipment. Firefighters in the bush do not have access to piped water, so their fire trucks are designed to function as water tankers. Pumps on the trucks can pump water into the tanker as well as squirt water through hoses to fight the fire.

Check out fire stations, uniforms etc:

<http://home.vicnet.net.au/~rowvcfa/main.html>

All you need to know about volunteer fire brigades:

www.cfa.vic.gov.au/

If you need to maintain firefighting equipment:

www.fem.webcentral.com.au/

Information for schools: www.cfa.vic.gov.au/schools.htm

The impact

Fires are a natural part of many ecosystems in Australia. Aboriginal peoples used fire to manage the land. So why are people concerned? Under certain weather conditions when it is hot, windy and a low humidity, fires can spread rapidly and are a threat to people's lives, their homes, farms, animals and plants. Most fires are actually caused by people. It is hotly contested whether there are more fires now than before European settlement. Too many fires can destroy valuable habitat while not enough fires can increase the amount of fuel.

⚠ Risk assessment

Ask students to present their designs of experiments and activities for "Risk assessment". Instruct students about modifications, provide appropriate instruction, safety equipment and supervision. When necessary do the experiment or activity as a teacher demonstration or abandon it altogether.

The challenge

Students can investigate aspects of firefighting by completing a challenge:

1. Visit a volunteer fire brigade, ask a volunteer fire brigade to visit the school or find one on the Internet. Inspect and record the resources and tools they use. View their training videos.
2. How does firefighting clothing protect firefighters? Devise a test that demonstrates which materials are most suitable. (Students may require a fume cupboard.)
3. Using vinegar and bicarbonate of soda, design and make a fire extinguisher that can extinguish a candle. Explain why the candle is extinguished.
4. Link with a city school and a country school to identify differences in their fire emergency plans.
5. Investigate ways to propel water by putting it under pressure (e.g. use syringes, water pistol mechanism). Design and make a pressure machine. On a garden bed have a competition to find out which method squirts the water the furthest.
6. Develop a bushfire emergency plan for a country school, a country home, or for visitors to a local park making sure that children are safe from radiant heat. Develop an educational program to implement the plan.
7. Evaluate the school's fire emergency plan.

Extra information

Discovering how hydraulic forces work is fascinating. Starting with a simple syringe or plastic milk bottle, examine how the pressure and the size of the hole affects how far the water can be propelled. Pull apart simple disposable spray pumps that are part of cleaning containers. Inspect any other pumps that students can bring to school. Students can also look at aquarium air pumps and speculate how they work.

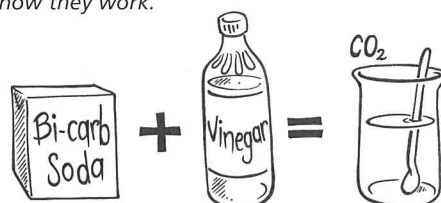

Bush Survivors

Aboriginal Knowledge – Fire

(Adapted From *Ochre to Eel Traps*, pages 53–55)

The science

Aboriginal people are able to start fires by rubbing or twirling two pieces of wood together and adding small amounts of fuel to smouldering dust generated by the sticks. By blowing hard a flame is produced and more fuel added. Sometimes flints were also used. Starting a fire is a skillful task so when Aboriginal people were on the move it was more convenient to take a fire stick. The specially chosen wood could smoulder for hours and be used to light new fires.

Fire had many uses that included:

- cooking meat and cakes
- staying warm
- having light at night
- hunting and managing the land by clearing vegetation and promoting certain plant and animal species
- making tools and melting resins
- corroborees and burial ceremonies.

From *Ochre to Eel Traps*, second edition, published by Science Education Association ACT, 1999, can be obtained from SEA*ACT GPO Box 1205 Canberra ACT 2601 (reduced cost for ASTA members).

Useful websites for teachers and student research:

www.sofweb.vic.edu.au/koorie
www.yarrahealing.melb.catholic.edu.au
www.loreoftheland.com.au
www.sbs.com.au/icam

Reference: Barlow, Alex *Aboriginal Technology, Fire* 1994 Published Macmillan Education Australia.

The impact

The Aboriginal people did not remain in a single location but moved around. They didn't have a large impact on the environment. However their regular burning of small areas of grassland seems to have had a positive result, helping plants to regenerate and creating fresh green food for many animals.

⚠ Risk assessment

Ask students to present their designs of experiments and activities for "Risk assessment". Instruct students about modifications, provide appropriate instruction, safety equipment and supervision. When necessary do the experiment or activity as a teacher demonstration or abandon it altogether.

The challenge

Students can investigate the use of fire by Aboriginal people by completing a challenge:

1. Describe how Aboriginal people used fire.
2. Write a story about life around an Aboriginal campfire. Specify a time in history e.g. 200 years ago, the present.
3. Interview a local Aboriginal identity about the importance of fire.
4. Compare how Aboriginal people used fire with how people use fire in the bush today.
5. Investigate under what conditions a fuel burns fastest. What are the conditions that provide the most efficient outdoor fire?
6. Test a range of materials as suitable fire sticks or have a competition using local fuels to light a small fire and toast a slice of bread.
7. Design a container that will keep matches dry under most conditions. Test the container using matches.
8. Create a tool and attempt to make a fire using Aboriginal fire-making techniques. How long does it take before the wood becomes hot?

Extra information

Students will find out from experience that using sticks is not an easy method to produce a fire. Twirling a long hard wooden stick in a flat softer piece of wood will provide the quickest result. As students are unlikely to make a fire by using these methods, look at other ways of creating fire in survival situations. This can include removing a lens from a camera. Focus the sunlight through a lens and a fire can be made very quickly.

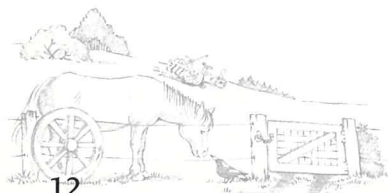

Bush Technology

Introduction to Bush Technology

The original bush technology was developed by the Aboriginal people and was part of their culture. They required a set of tools for hunting and gathering food. They used raw materials from plants, animals and specific types of rocks.

Today those living in rural and remote locations need to be self-reliant. It is often easier to do many jobs like repairing equipment oneself, rather than having someone doing a lot of travelling to get the job done. This self-reliance is a long tradition that started with the first Australians. Early European farmers started with large bush blocks. They needed to establish a home and a farming business in an unfamiliar environment. Their tools were designed for European conditions.

These farmers were keen to adopt new technologies to achieve their goals which focused on the establishment of viable farms. Some farmers learned from local Aboriginal people. Many made their own inventions. Wire and corrugated iron enabled farmers to construct their farms with minimal labour. After the First World War tractors did the work of horses. Modern farming requires that farmers adopt many new practices to improve their production and to care for their environment.

The themes:

Aboriginal technology – boomerangs
Corrugated iron
Fences
Ploughs and harvesters
Global Positioning System (GPS)

Windmills and pumps
Solar energy
Diesel engines
Inventions

Aboriginal technology – boomerang

(Adapted from *Ochres to Eel Traps*, pages 5 and 6)

The science

There are two forms of the boomerang. The Aboriginal people carved and decorated some boomerangs for recreational and ceremonial purposes. These boomerangs are carved to perform like an aircraft wing, flat at the bottom and curved at the top. The aerodynamics is not fully understood, however the difference in air pressure from the top and the bottom provides lift as it spins through the air. But this lift is not even as it spins and the boomerang wants to tip sideways. The spinning motion counteracts the tipping forces of the boomerang. The uneven forces acting on a spinning boomerang makes it act like a gyroscope resulting in a curved trajectory. Aboriginal people also designed boomerangs or throwing stick for hunting. These could be accurately thrown at prey and were not designed to come back.

Useful websites for teachers and student research:

www.sofweb.vic.edu.au/koorie
www.yarrahealing.melb.catholic.edu.au
www.loreoftheland.com.au
www.sbs.com.au/icam

References: Barlow, Alex *Aboriginal Technology, Boomerangs and Throwing Sticks* 1994 Published Macmillan Education Australia. Reference: Barlow, Alex *Aboriginal Technology, The Spear* 1994 Published Macmillan Education Australia.

The impact

The Aboriginal people were very skillful in making tools. Their boomerang used as throwing weapons could be thrown with a great deal of force inflicting a deadly blow to prey.



Popperangs

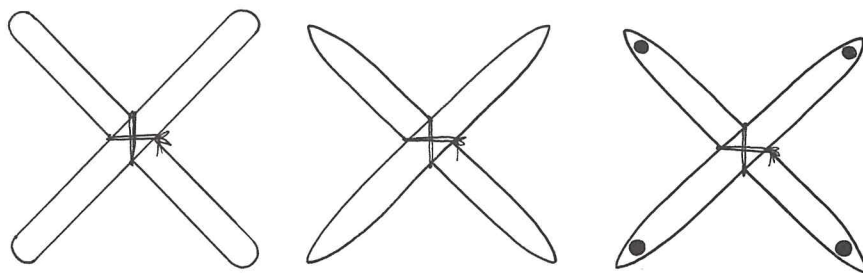

! Risk assessment

Ask students to present their designs of experiments and activities for "Risk assessment". Instruct students about modifications, provide appropriate instruction, safety equipment and supervision. When necessary do the experiment or activity as a teacher demonstration or abandon it altogether.

The challenge

Students can investigate Aboriginal tools and the flight of a boomerang by completing a challenge:

1. Find out what tools and weapons Aboriginal people used. Present findings as a wall poster.
2. Using instructions, construct a model popperang from card and test it.
3. Plot the path of a popperang or boomerang, e.g. mount some small light emitting diodes to a boomerang and photograph it at night.
4. Using cutout card, experiment with different shapes to find out if they behave like a boomerang. Is there a difference between a flat surface and a curved surface? Do rounded edges make a difference in flight? Does a boomerang need to have its characteristic bent shape?
5. Discuss what people can do to respect Aboriginal objects in archaeological sites, museums or in private hands, as well as sacred sites.

Extra information

A popperang consists of two flat sticks or pieces of heavy card joined at the centre to form a cross. When thrown in a spinning motion it can be made to perform like a boomerang.



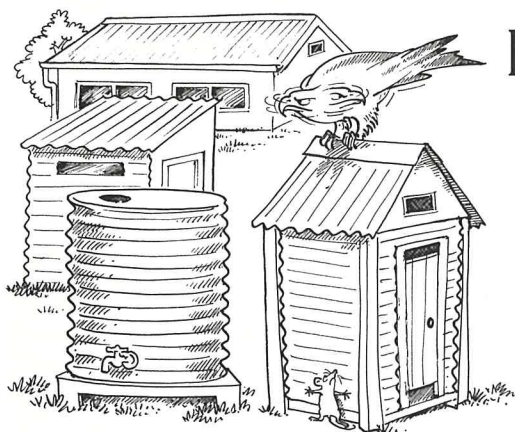

Bush Technology

3. Examine the properties of rust or look at corrugated iron used in the local area and rate them from the oldest to newest iron.
4. Use a digital camera to photograph over time the rusting sequence of uncoated iron. Create a timeline of images.
5. Test different designs of corrugated card. Compare the strengths of different corrugated designs. Present the findings in a chart.

Extra information

Visit a hardware store and examine products made from galvanised iron. Many more products in the past were made from this material including buckets, watering cans and even kitchen utensils. Find products that are now substituted for galvanised iron. Look for tools that are used to cut corrugated iron.

Corrugated iron

The science

Iron is produced from iron ore in large smelters. Iron is manufactured into steel. Steel is an alloy (mixture) of iron, carbon and other chemicals used to change the properties of the iron to the properties required. The surfaces of steel and iron will rust (corrode) if in contact with oxygen. Also acids, salts and bases cause corrosion. Rusting is like a very slow form of burning. Metal atoms, ferrous, combine with oxygen to form rust. There are many ways to protect iron and steel from rusting, often by coating it with a surface of paint or a non-rusting metal like zinc or tin. When steel is coated with zinc, it is called galvanised iron. Galvanising can be achieved in several ways. One method is to degrease the steel and dip it into molten zinc. Another method is by electroplating. An electric current is passed through the iron in a solution of zinc salts and zinc. The current makes the zinc dissolve in the solution and then coat the steel.

Galvanised iron (steel) has the following properties:

- It is made from sheets of steel.
- The steel has been coated with zinc.
- The sheets of steel have been corrugated to provide the sheet with much greater strength.

Galvanised products can be seen on:

www.gaa.com.au/links.htm and

www.galvanizeit.org/facts_about_zinc.htm

The impact

The first European settlers in the bush had only manual tools. The local hardwood trees were very difficult to saw and shape and not very suitable for construction. Initially, transport into the bush and onto farms relied on the slow horse and cart. A lot of corrugated iron could be stacked onto a cart or wagon. This building material made excellent sheds and roofs for houses. The roofs were then used to collect water and stored in corrugated iron tanks. Corrugated iron quickly became the most popular construction material in the bush.

Risk assessment

Ask students to present their designs of experiments and activities for "Risk assessment". Instruct students about modifications, provide appropriate instruction, safety equipment and supervision. When necessary do the experiment or activity as a teacher demonstration or abandon it altogether.

The challenge

Students can investigate various properties of corrugated iron by completing a challenge:

1. Find out how corrugated iron is coated to prevent the steel from rusting.
2. Investigate what modern materials can be substituted for corrugated iron.

Fences

The science

As European settlement progressed, squatters with their livestock occupied large tracts of land. The herds of cattle or sheep were kept together under the constant watchful eyes of the squatters. Soon the land was sold to farmers who needed to contain and control their stock using fences. In the managing and breeding of livestock, it is desirable to develop the best breeds and therefore obtain the highest productivity and greatest monetary return. This can only be achieved when the farmer can determine which animals can breed. This is usually accomplished by having a few valuable male breeding animals and making sure any young males born can't reproduce by removing their sex organs. When large areas were planted with crops, fences kept out livestock.

As the rabbit plagues swept across southern Australia, wire netting was employed to try and prevent these devastating animals from spreading. At first fence builders tried to dig deep trenches below the fence in which they buried the wire netting, to try and stop the rabbits from burrowing under the fence. The rabbits, however, just dug deeper, went under the fence and got onto the other side of the wire. A lazy fence builder did not want to dig deep trenches and attempted to cheat. Instead of burying the bottom of the fence in a deep trench he just bent the wire netting over at ground level. He spread soil over the part of the wire netting lying on the ground so it looked as if it had been dug into a trench. This created an L-shaped fence. The farmer to his surprise found this fence was more effective at stopping rabbits. The rabbits when they found a fence only dig at the base of the fence. With the wire netting bent over the rabbits could not dig through the wire and soon gave up.

Fencing wire is manufactured from steel and is coated in zinc (galvanised) to prevent it from rusting. See the previous topic about galvanised iron.

Locate some information about the serious problems caused by rabbits: www.csiro.au/communication/rabbits/qa1.htm

The impact

Traditional European fences were hedges, rock walls and post and rails. The amount of fencing required on large grazing properties made it impossible to fence large areas in a short time using these methods. Post and wire fences enabled farmers to manage their stock, crop and land use.

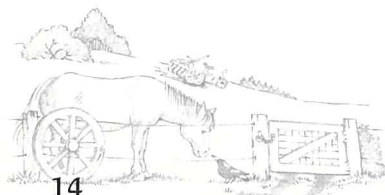

Bush Technology

⚠ Risk assessment

Ask students to present their designs of experiments and activities for "Risk assessment". Instruct students about modifications, provide appropriate instruction, safety equipment and supervision. When necessary do the experiment or activity as a teacher demonstration or abandon it altogether.

The challenge

Students can investigate the construction and impact of fences by completing a challenge:

1. Explain why Aboriginal people didn't need fences.
2. Where is the longest fence in the world and why was it built to control dingoes? How is it maintained?
3. Find out how fences were designed to control rabbits.
4. Construct a model of a fence and find solutions for keeping the fence upright and the wire taut. Include extra supports on the end posts so that the tension on the string (simulated wire) does not pull the post over.
5. Contrast the materials and designs used to build fences in the local area. Which designs are suitable to contain large areas?
6. Compare the strategies scientists use now to increase productivity of crops and stock with the farming methods of the past.
7. Design and build a device that can place tension on a string. Describe how the forces are applied to make the string taut.
8. Farmers use fences to control the quality and breeding of their stock and crops. There is a fear that genetically engineered food can quickly interbreed with normal crops. Debate the issue "fences can't contain genetically modified foods".

Extra information

It is safer for students to use string to simulate wire than to actually use wire. To use string as a simulated fence in experiments, students can make a loop of string around a thick covered book, use table legs or chair legs. There are a number of ways to create tension in wire and they all use forces applied by levers. They include:

- Rotating a long piece of metal to screw and twist up the slack in the wire.
- Special plates are attached to the two ends of the wire. A lever is used to wind the slack around the plate.
- Fence strainers have three sprung clamps that attach to two wires. By moving the lever back and forth, one wire slips through the clamps and creates the tension.
- Wire used in buildings under handrails needs to look neater and not have sharp cut off points. This wire has a screw and bolt at either end. A spanner (lever) is used to tighten the wire.

Students are likely to invent their own methods.

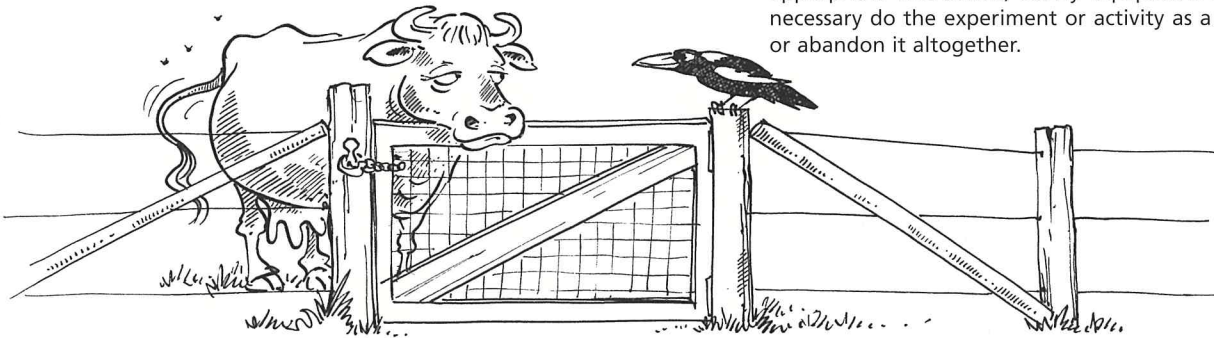

Ploughs and harvesters

The science

The efficient growing of crops has enabled humanity to feed the billions of people on the Earth. From the earliest times when people started growing their food they discovered that their crops would grow better if they managed the soil and controlled the weeds. By turning over the soil, weeds were killed, it was easier to plant crops, the crops had loose soil for their roots to grow, more water soaked into the soil and the soil was aerated. Only a small area can be dug by hand. The next innovation, thousands of years ago, was the invention of the plough pulled by an ox, buffalo or horse. At first the plough was a large stick that scratched the ground. As iron became more available, the cleverly shaped ploughs not only dug into the ground, but the plough also turned the soil over. With the advent of tractors, a few people could crop large areas of land. New farming methods are replacing the plough. With some crops, instead of ploughing, the stubble is burnt off and the seeds directly drilled into the ground. These methods used in Australia's dry inland can reduce the drying and eroding of soil, particularly through the action of wind. Farmers also kill the weeds with herbicide and then don't need to burn the stubble.

As larger areas were being farmed the crops were still being harvested by hand. Then harvesters were invented that could cut the crop and separate the grain from the straw, quickly and efficiently.

Find out about different ploughs and harvesters:

www.museum.vic.gov.au/sunshine/index.htm and

www.samd.com.au/single_bedformer.html and

www.goodwinkenny.com.au

Inspect some tractors:

www.starwon.com.au/~painter/WA/museum.htm and

www.bareco.com.au and www.deere.com and www.deere.com.au

Refer to rural magazines such as the Weekly Times, Country Life and Land newspaper.

The impact

Modern farming techniques make food production very efficient and can provide large quantities of cheap food. However these farmed areas lost a lot of their original biodiversity. Ploughing also damages soil structure and may kill many beneficial organisms. Most modern farming techniques also require the application of fertiliser. Some of this fertiliser gets washed into the waterways and the ecology of streams, rivers and lakes is disturbed. It is important that scientists investigate ways to reduce the impact of large-scale crop farms on the environment.

⚠ Risk assessment

Ask students to present their designs of experiments and activities for "Risk assessment". Instruct students about modifications, provide appropriate instruction, safety equipment and supervision. When necessary do the experiment or activity as a teacher demonstration or abandon it altogether.

Bush Technology

The challenge

Students can investigate ploughs and harvesters by completing a challenge:

1. Use the Internet or rural magazines to find out what kinds of ploughs and harvesters are used in farming. Present a chart of the findings.
2. Find out how much grain can be gathered by a modern harvester in an hour. What area does it cover in this time? Compare this with the McCormick reaper of the mid-nineteenth century.
3. Test kitchen utensils (spoons, forks and knives) in the garden as ploughs. Angle the utensils as they are pulled through the soil or sand and find the most efficient way of turning over soil or sand (in a sandpit). Present a report.
4. Compare the environmental impact and benefits to people of modern farming with agricultural practices of the Neolithic period.
5. Write, video, illustrate, record etc. a commercial or advertisement to sell a particular make of plough or harvester.
6. Design a model plough and construct it from cardboard. Test the model in a simulated paddock using soft agar or jelly in a shallow baking tray.

Extra information

Modern farming needs to use only a few people to grow large quantities of food. Demonstrate some basic handtools like spades and forks and see how much effort is required to turn over soil. Design and construct simulated ploughs from kitchen utensils or heavy cardboard and find what kind of shapes work best. Students can move their simulations through sand or make trays of jelly or agar.

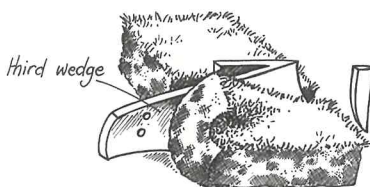
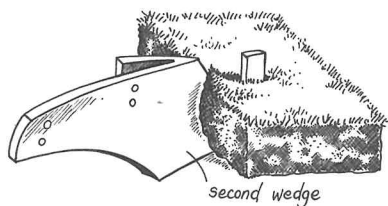
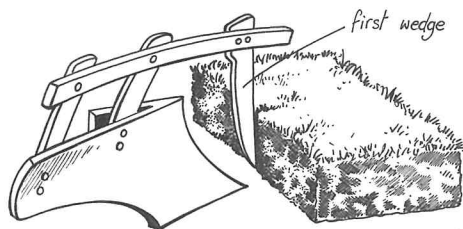

GPS

The science

GPS is short for Global Positioning System and has been established to help the military in a range of ways including guiding missiles to their targets. The USA and Russia have made the systems available to the general public. Handheld and vehicle mounted GPS receivers are becoming more common. Depending on the degree of sophistication built into the receiver, it can provide an accurate method for location anywhere on the planet to within 15 metres. The system that enables this technology to work consists of over 24 satellites rotating around the Earth every 12 hours. With the input of four satellites it is possible to compute position, height, speed and direction of movement.



Find out more about GPS hand sets: www.magellan.com.au
More information about Global Positioning:
www.colorado.edu/geography/gcraft/notes/gps/gps_f.html

The impact

There are many more applications for using this technology than just for bush walkers. The technology can be linked to road maps and used by emergency services or even as a convenient way for drivers to find their way around. On very large cereal farms, tractor drivers can use the technology to plough and then sow by placing the seed in very straight lines. This enables them to maximise the spread of seed they sow over the area.

The challenge

Students can investigate the application of a GPS system by completing a challenge:

1. Using the Internet, find out how the GPS system works.
2. Write a newspaper article about a search and rescue team using GPS to rescue lost bush walkers.
3. Using a GPS handset, find North, South, East and West. Find the school's location. Use the GPS handset to create a trail.
4. Compare the application of GPS technology with the use of a map and compass.
5. Devise a way to use GPS technology to plough a straight line over a very long distance. Work out a way of testing this out.
6. Think of creative ways GPS may be used in the future. Present the ideas as a television documentary.

Extra information

If the school would like to hire a GPS handset contact info@magellan.com.au



Bush Technology

Windmills and water pumps

The science

Wind energy has a long history in the bush for pumping water. Bores are drilled to tap water in the watertable, deep in the ground. Windmills are used to pump the bore water out of the ground. They are also used to pump water from dams into a header tank. The header tank provides enough pressure for water to be piped around the farm.

There are different ways to pump water. Some windmills have a piston style pump that draws water up a tube and through a valve. Water is drawn up as the piston is pulled up. It's like a bicycle pump, but with the leather plug back to front. When the piston is pushed down, the valve closes to prevent water being pushed back down. Other windmills have long turning screws running down the centre of a pipe. This is known as an "Archimedes screw". Water moves up the screw as it turns. Electrical pumps have a set of spinning angled blades that force the water through like a jet engine.

Find out more about windmills:

www.wdmoore.com.au/

www.wdmoore.com.au/wdm/wpf.htm

www.wdmoore.com.au/Alderdice.htm

www.windmillworld.com/

www.geocities.com/miltoncuevasm/

Browse through rural magazines like the Weekly Times and look at windmill and pump advertisements.

The impact

Windmills are a low maintenance way of providing livestock with a constant water supply. This method of pumping water from bores has enabled grazing in areas where there is no permanent fresh surface water. This additional water has also benefited both native and feral animals. Eventually improvements in wind energy technology will enable country areas to generate most of their electrical needs. It is anticipated by some people that wind generators may be able to replace coal fired power stations and thus reduce some of the greenhouse emissions.

⚠ Risk assessment

Ask students to present their designs of experiments and activities for "Risk assessment". Instruct students about modifications, provide appropriate instruction, safety equipment and supervision. When necessary do the experiment or activity as a teacher demonstration or abandon it altogether.

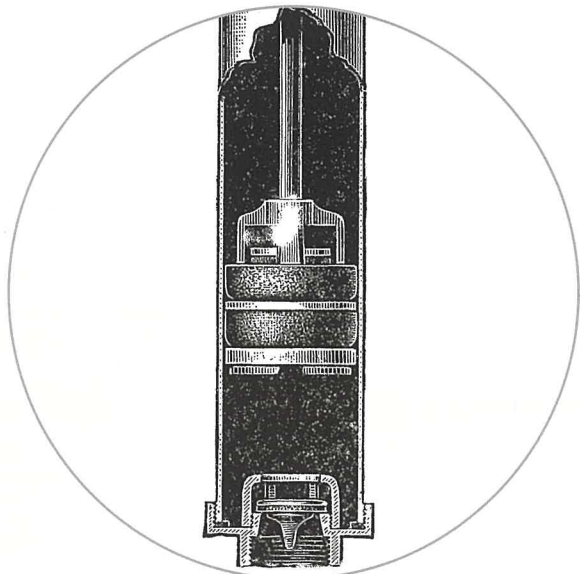

The challenge

Students can investigate the features of windmills and pumps and the transfer of forces by completing a challenge:

1. Find information from rural magazines like the Weekly Times about windmills and pumps.
2. Draw a flow chart of how one type of pump works or how a windmill works.
3. Design an experiment that shows whether the wind speed changes with distance from the ground.
4. Investigate how syringes, water pistols and hand sprays pump water. Describe the conversion of forces. Pull apart a bicycle pump and convert it to a water pump.
5. Make models and compare the effectiveness of different shaped windmill blades. Present the findings as a scientific report.
6. Design and construct a windmill that can lift a weight 50 cm from the ground. (Extension – and return it to its original position.)
7. Debate the advantages and disadvantages of wind power generators.

Extra information

To find out if wind speed changes with distance from the ground you will need a strong breeze. Students may use kites and measure the strength of the pull on the string. They could stretch a spring, elastic band or measure the distance the operator moves if they let the tension go for two seconds. They could tie identical ribbons every 50cm along a rope and run it up a flag pole and see how they flutter.

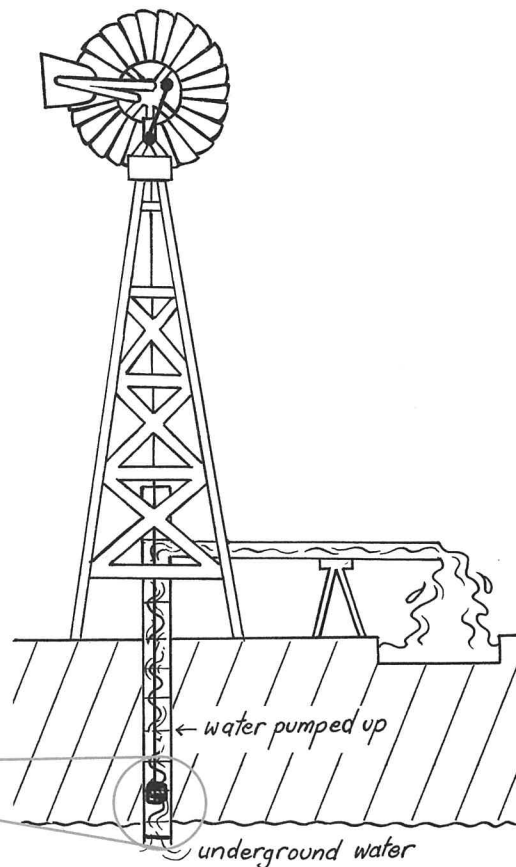

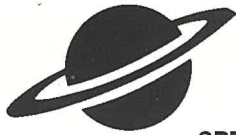

SPECTRA

Science has its rewards...

SPECTRA – an ongoing program for primary and secondary students to become interested in working at a series of scientific activities and encourage their initiative.

SPECTRA covers a broad range of topics. Badges and certificates are awarded once an appropriate number of activities have been completed. Contact ASTA for a free information kit.

Tel: 02 6282 9377 Email: asta@asta.edu.au



*Bring your
Science
Curriculum alive
with a visit
to the Zoo!*

Taronga and Western Plains Zoos are stimulating learning environments where your students can explore and understand the science curriculum.

Our Zoo Education service provides exciting classroom lessons with live animals and support materials specific to topics from Stages 1 to 6.

For Zoo lesson or visit enquiries:

Taronga Zoo, Sydney
Phone: 9969 2455
zooed@zoo.nsw.gov.au



Western Plains Zoo, Dubbo
Phone: 6884 4530
wpzooed@tpgi.com.au

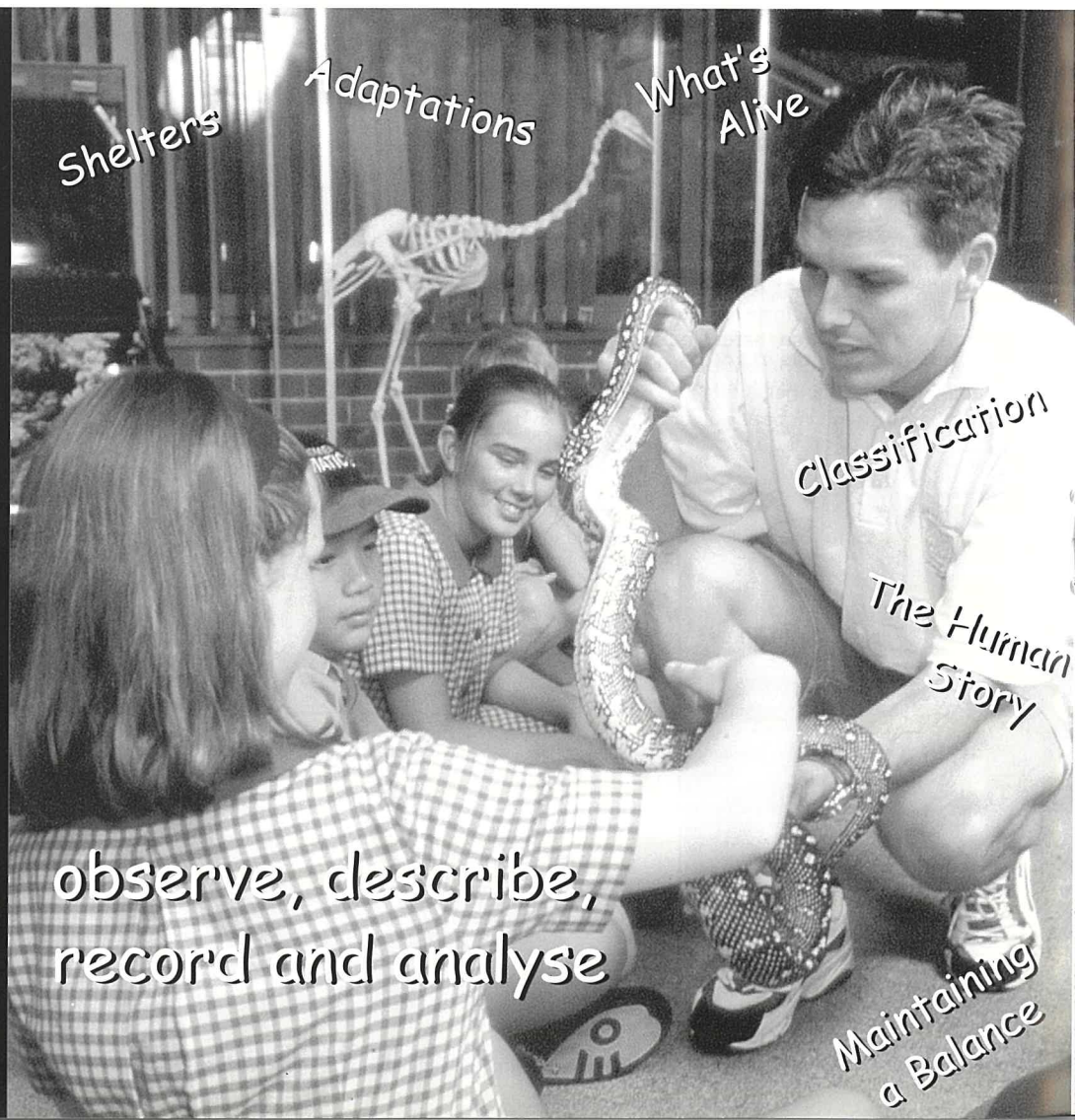

Shelters

Adaptations

What's Alive

Classification

The Human Story

Maintaining a Balance

*observe, describe,
record and analyse*

2002 YEAR OF THE OUTBACK

2002 Australia's Year of the Outback...

Uniting Australians to focus undivided attention on outback Australia; its immense diversity, its extraordinary past and its vital role in our future.

www.outback2002.com



2002 Year of the Outback®

For more information on the Year and its events visit our website www.outback2002.com or contact us at Outback 2002 Ltd 28 Mein St Spring Hill Q 4000 Ph (07) 3837 0200 Fax (07) 3837 0201 Email outback@outback2002.com

Inspire your students to acquire effective environmental management skills and gain community, State or possibly national recognition.

Enviro Smart

An easy-to-follow and hands-on environmental resource with supporting internet case studies that assists teachers and students at both the upper primary and secondary level to develop and implement a **School Environmental Management Plan**.

For further details visit our website - www.minerals.org.au/pages/page8_272.asp

To order: Fax Back to Minerals Council of Australia 02 6279 3699

Name: _____ School: _____

Address: _____

Ph: _____ Fax: _____ Email: _____

Order form also available at: www.minerals.org.au/media/order.htm



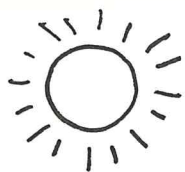

Bush Technology

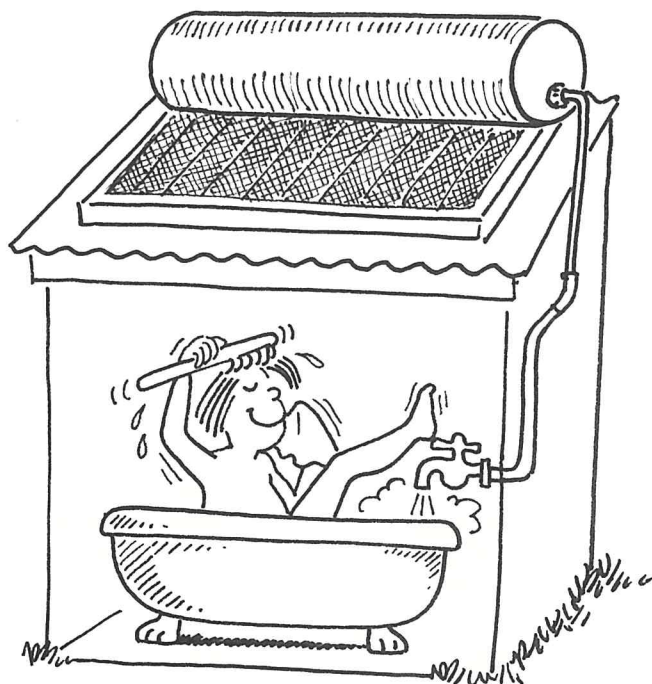

⚠ Risk assessment

Ask students to present their designs of experiments and activities for "Risk assessment". Instruct students about modifications, provide appropriate instruction, safety equipment and supervision. When necessary do the experiment or activity as a teacher demonstration or abandon it altogether.

The challenge

Students can investigate solar energy by completing a challenge:

1. Create an electrical current by using a solar cell to run an application, e.g. a model car.
2. Measure how water becomes hot when left in black tubing or in a garden hose in the Sun. Design and conduct an experiment that identifies some variables that will increase the temperature of the water. Take care that students are not splashed with hot water.
3. Design an experiment that examines the effect of colour on the ability of an object to absorb solar radiation.
4. Investigate the optimal conditions to run a solar cell.
5. Construct a solar shower that can supply warm water for three minutes.

Extra information

- Black objects absorb the most solar radiation.
- Positioning the surface to face the sun and maximise the radiation. If the solar heater is fixed, the best direction is north. The best angle or gradient is related to the latitude of the location.
- If it is to be attached to a storage tank, remember that as water is heated it moves upwards. To create a flow, a zig-zagging configuration of tubes will flow while a spiral configuration of tubes will have bottlenecks.

Solar energy

The science

Most of the solar energy used by people is by indirect means. Plants use the Sun's energy, carbon dioxide and water to create simple sugars. Plants can then build complicated proteins and other molecules. People rely on plants and the animals that eat plants, to provide energy, proteins etc. in the form of food.

These are the main ways people can directly use solar energy:

- For passive heating of buildings, greenhouses etc. This can be improved in Australia by facing the windows of the building towards the north.
- By passing water through a solar heat collector, it will be heated during the day.
- By converting solar radiation directly into electricity through photocells. Photocells are made of thin slices of semiconductor material. Each cell can only generate a small voltage so many photocells need to be linked together into panels.

Search these sites for any aspect of alternative green energy:

www.seav.vic.gov.au and www.seda.nsw.gov.au

The impact

Using renewable energy sources can help the world reduce the rate of greenhouse gas emissions into the atmosphere. Only a small amount of solar energy is being directly used. As yet solar panels are not cheap and reliable enough to be used by large energy companies. But solar energy is relatively efficient when produced on site, as there is no need for massive transmission infrastructure. Another limiting factor is there is no efficient, easy and environmentally friendly way of storing large quantities of energy for nighttime use. Fuel cell technology in the future may provide a suitable solution for storing energy.

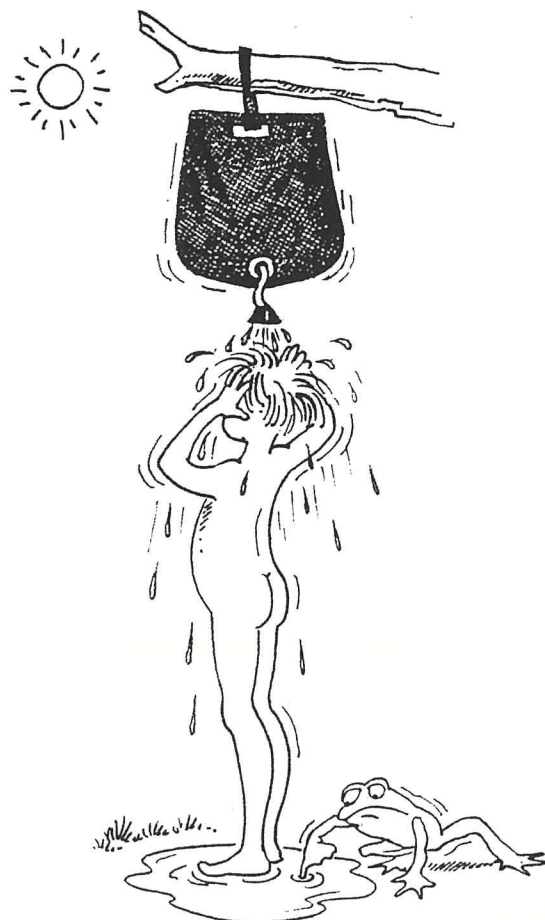

Bush Technology

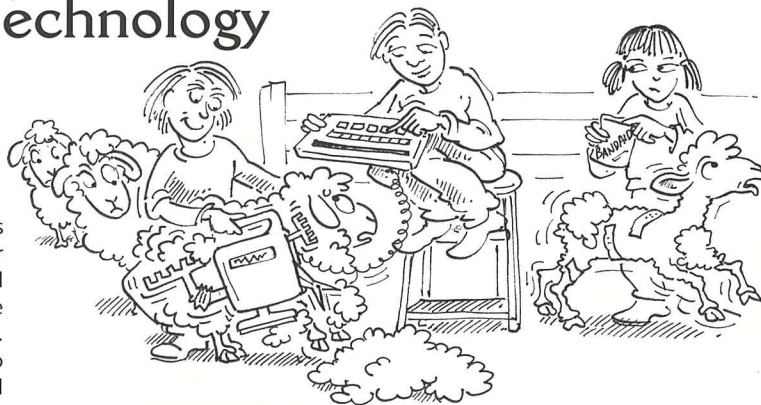

Diesel engines

The science

The names diesel and petrol engine refer to the fuel the engines burn. Diesel fuel is a light oil and does not evaporate, burn or explode as readily as petrol. The mechanical operation of a diesel engine is different to that of a petrol engine. In a petrol engine, the fuel is ignited in the cylinder by a spark generated by a spark plug. On every second down stroke, petrol and air mixture is drawn into the cylinder. As the piston reaches the top of the stroke, the petrol and air are compressed, the spark ignites and explodes the petrol. This is what provides the power to the engine. The diesel engine does not have spark plugs. The oil and air are compressed twice as much as in a petrol engine. This very high compression is enough to explode the oil. Compared to petrol engines, diesel engines have greater torque or pulling power, use less fuel and the engines last longer. However diesels have less acceleration and tend to be slower and heavier.

Search around this site for some interesting history:

www.deere.com/deerecom/_Engines+and+Components/default.htm

The impact

Diesel engines power most large farm machines and trucks as well as earth moving vehicles that build roads, dams etc.

! Risk assessment

Ask students to present their designs of experiments and activities for "Risk assessment". Instruct students about modifications, provide appropriate instruction, safety equipment and supervision. When necessary do the experiment or activity as a teacher demonstration or abandon it altogether.

The challenge

Students can investigate diesel engines by completing a challenge:

1. Describe a diesel engine with the help of books, Internet or a guest speaker. Name some machines that have diesel engines.
2. Write a short report or act out the process on how a diesel engine is started and how the fuel is ignited when it is running.
3. Inspect a vehicle or other machine with a diesel engine and describe some of its components.
4. Pull apart an old engine that has been cleaned for the purpose.
5. Compare diesel engines with petrol engines. Present the findings as a chart.
6. Plan a marketing campaign to encourage people travelling in the country to use diesel vehicles.
7. Debate the following topic "Diesel engines are better for the environment".

Extra information

Ask a parent with a good knowledge of engines to assist inspecting a diesel vehicle or a car if a diesel is not available. Divide the class into groups of four or five and allow the parent to take the students to the vehicle and describe the function of the various components. Students can make a list of these components and describe what functions they perform.

Inventions

The science

Australians have an incredible record for scientific discoveries and innovative inventions. The Hills clothesline, the Victa lawnmower and the wine cask are some of the more familiar Australian inventions. People in the bush had to be self-reliant and they regularly invented solutions to their everyday problems.

These are some examples of Australia's fabulous inventors:

- John Ridley and John Wrathan Bull in the 1850s invented the first wheat harvester in South Australia.
- A 17-year-old Hugh McKay in 1882 was tired of using three machines to harvest thresh and clean the grain. From junk found around the farm he made a reaper/harvester that was able to strip, thresh and bag clean grain in a single machine.
- Richard Smith invented the stump-jump plough after he found that his broken plough worked better when it hit hidden underground stumps.
- James Harrison noticed his fingers getting cold when cleaning printing presses with liquid ether. He spent 5 years experimenting to produce an ice making machine. By pumping ether through a copper coil around a barrel of water he could freeze the water into a block of ice.
- Louisa Lawson, mother of Henry Lawson, was a publisher, journalist, poet, women's rights activist and an inventor. She had been a postmistress in the bush in her younger days and detested opening the mailbags sealed with twine and wax. In 1895 she invented brass buckles to fasten mailbags. This was patented in 1896 and supplied to the post office.
- David Unaipon (his picture is on the \$50 note) an Aboriginal was an inventor, writer and poet. In 1909 he patented an improved shearing hand-piece. He also designed motors and even suggested designs for a helicopter. He developed a reputation for being "Australia's Leonardo".
- Alf Traeger in 1928 hitched a two-way radio onto a small generator powered by a person peddling. This simple invention enabled the Flying Doctor Service to communicate with people in the outback.

Check out a timeline of Australian inventions:

<http://members.ozemail.com.au/~macinnis/scifun/timeline.htm>

Find out more about David Unaipon:

www.rba.gov.au/Currency/people_on_notes.html

www.ctie.monash.edu.au/hargrave/index.htm

Inventors Hall of Fame: www.invent.org/book/book-index.html

Reference: Barlow, Alex *Aboriginal Technology, Fibrecraft* 1994
Published Macmillan Education Australia.



Bush Technology

The impact

People in the bush are isolated and often have unique problems. They have solved their problems by inventing solutions.

! Risk assessment

Ask students to present their designs of experiments and activities for "Risk assessment". Instruct students about modifications, provide appropriate instruction, safety equipment and supervision. When necessary do the experiment or activity as a teacher demonstration or abandon it altogether.

The challenge

In this activity, students are encouraged to follow in this grand tradition and try their hand at being a bush inventor. This activity can be developed as a class competition for fantastic inventions. Discuss the idea with the class and build a concept map about different competition categories. Ask students to choose a challenge from the list below or pursue their own ideas.

Design or make one of the following:

1. a bush bed that is free of mosquitoes
2. a simple bush toilet that is free from flies
3. a method for getting water from a farm dam to the home and garden
4. a way to keep sparrows from nesting in the roof
5. a way of protecting the home from bushfires
6. an automatic watering system that comes on when it has not rained
7. a method for automatically harvesting large yabbies from a dam
8. a way to protect chickens from foxes
9. a cutting implement used by Aboriginal people
10. a carry bag using traditional materials used by Aboriginal people
11. paints using the material and techniques used by Aboriginal people
12. a fish trap as used by Aboriginal people
13. a method to pull out weeds without bending over
14. a tool to pick fruit so a ladder and climbing is not required
15. a way of quickly cleaning bicycles and trail bikes
16. a better way of cleaning and protecting horse equipment
17. a horse feeding box that keeps vermin out
18. a solution to preventing birds from eating fruit from fruit trees
19. dyes to change colour of materials
20. perfumes using natural oils
21. paints from natural materials
22. the ultimate BBQ utensil
23. design fashionable clothing that protects the body and face from the sun or cold weather (experiment with materials and find the material and colour that is coolest and most comfortable in hot weather and warmest in cold weather)
24. a small garden bed, growing frame and watering system that will grow the student's favourite fruits, nuts or vegetables.

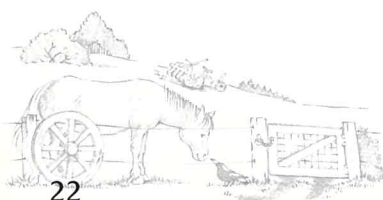
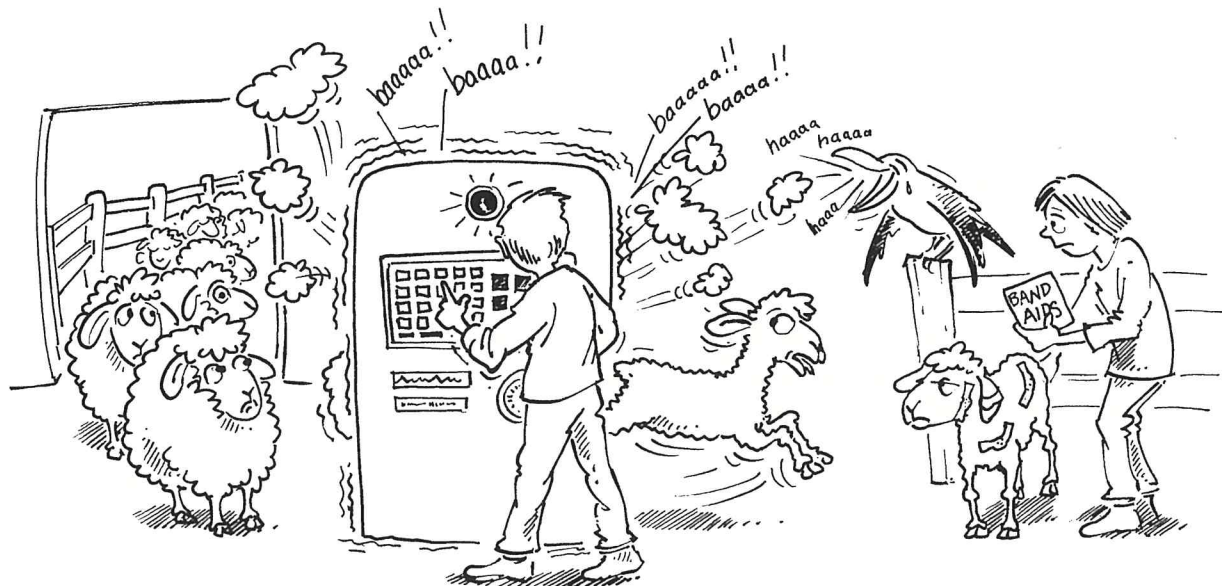

Bush Living

Introduction to Bush Living

Compared with 100 years ago, life in rural and remote areas has fewer communication and transport problems. People are able to educate their children and obtain medical assistance when required. Being able to quickly go to a shop is not an option and many services like garbage collection are not available.

Many people enjoy camping in the bush. They need to take all their gear and food with them. Often they also need to take water and toilet facilities. Campers should protect the areas they are staying in and take their garbage home.

Communications

The science

The first electronic services available to people in the bush were in the form of telegraphs sent using electrical pulses using Morse code. People in very remote areas only had sporadic access to mail until Alf Traeger in 1928 hitched a two-way radio onto a small generator powered by the person peddling. This simple invention enabled the Flying Doctor Service to communicate with people in the outback.

A summary of the development of electronic communications in Australia is as follows:

- 1821 – First postal service began to Tasmania, other colonies followed soon after.
- 1859 – First telegraph service linking capital cities. Over the next ten years many regional centres linked up. By the end of the nineteenth century, people in Australia per head of population were sending more telegraphs than anyone else.
- 1872 – Todd completed the telegraph line across the Northern Territory, linking Australia to its Asian neighbours and thus the rest of the world. Within 20 years a vast network of telegraph lines had been installed.
- 1882 – First telephone exchange in Sydney was built.
- 1901 – Federation enabled the new government to take control of all forms of telecommunication.
- 1923 – First radio broadcast services were produced from capital cities.
- 1956 – Introduction of the television.
- 1966 – The satellite INTELSAT II provides the first satellite telecommunication links with the rest of the world.
- 1981 – First limited mobile telephone services in the capital cities (capacity of 4,000 customers).
- 1980s – (late) – Facsimile or faxes are being used by business. By 1992, 330,000 fax machines are in use.
- 1987 – All areas of Australia serviced by telephone.
- 1992 – First Internet service provider starts operations.

Details about the timeline of telecommunication developments:

www.academic.marist.edu/pennings/it.htm

Detailed history of telecommunications in Australia:

www.austehc.unimelb.edu.au/tia/525.html

Factual material on telecommunication:

www.telstra.com.au/classroom/index.htm

The themes:

Communications
Aboriginal living – bush food
Reuse

Mining
Bush archaeology

The impact

In the nineteenth century news about events around the world could take months to filter into Australia. Only those who could read and write could keep in contact with their relatives in Europe. For many living in the bush, they mostly saw people within their community.

Now people living in the bush and rural areas have a wide range of communication choices. Since the establishment of the Flying Doctor Service, people in remote areas have had access via radio to doctors' advice and have been able to call in emergencies. This technology was extended so children could receive education. The School of the Air provides children with education in many remote areas. In the most remote areas they can receive satellite TV. In the next few years most Australians will have fast access to the Internet.

Risk assessment

Ask students to present their designs of experiments and activities for "Risk assessment". Instruct students about modifications, provide appropriate instruction, safety equipment and supervision. When necessary do the experiment or activity as a teacher demonstration or abandon it altogether.



Bush Living

The challenge

Students can investigate communications in the bush by completing a challenge:

1. Describe how the Flying Doctors Service or the School of the Air uses communication technology. How has it changed over the years?
2. Translate emergency language/codes used by a variety of services, e.g. fire brigade, police, hospitals, into everyday language.
3. Design a survey to find out which forms of communication are used by families of the class (telephone, mobile, fax, email, letters, CB radio etc.). Use a software program to present the information as a graph.
4. Map the coverage of a digital phone tower or a CB radio.
5. Design and produce a device that allows people to communicate between rooms.
6. Find out the differences between mobile communication systems. Which best suit country people? Which best suit outback travellers?
7. Design the kind of mobile communication system you would most like to own in the future. Speculate what kind of communication systems might be available in the future.

Extra information

These are some police codes used in Dallas:

www.policescanner.com/dalcodes.html

Code 1:	Normal Response (no lights or sirens)
Code 3:	Emergency Lights & Sirens
Code 4:	Disregard
Code 5:	En Route
Code 6:	Arrived
Code 10:	Known Offender
Code 10C:	Known Dangerous Offender
Code 10W:	Felony Warrant
Code 10X:	Stolen Vehicle

Students can find out from people who work in the medical services, emergency services, air controllers or ham radio operators, what kinds of codes they use over radios and other forms of communication.

Aboriginal living – bush food

(adapted from *Ochre to Eel Traps*, pages 17–21)

The science

Aboriginal people used only their local resources for food. They had an intimate knowledge of their environment and moved seasonally to locations with abundant food. Local wildlife was hunted and tubers, seeds, fruits, nuts and edible invertebrates were gathered. They used various methods for fishing including spears and the construction of large fish traps in streams. Nominated clan members made medicines from plants. Poisons were extracted from toxic plants. The large red seeds from macrozamia cones (looks like a palm but is related to pine trees) are full of starch, but are also very poisonous. These were crushed, placed in bags and left in a running stream for over a month. The toxicity also declines when the seeds have fallen out of the cone and have been on the ground for many months. Women could tell from the smell which were safe to eat.

Hunting and gathering food was a daily activity. Children were educated in the local knowledge and developed the skills to utilise the resources of their environment.

Useful websites for teachers and student research:

www.sofweb.vic.edu.au/koorie

www.yarrahealing.melb.catholic.edu.au

www.loreoftheland.com.au

www.sbs.com.au/icam

Reference: Barlow, Alex. *Aboriginal Technology, Women's Technology* 1994 Published Macmillan Education Australia.
Gott, B. and Conran, J. *Victorian Koorie Plants* 1991, PO Box 666, Hamilton Vic.
Gott, B. and Zoca, N. *Koorie Plants, Koori People* 1992 Koorie Heritage Trust Victoria.
Video: *Using Bush Foods* Video Education Australia, 111A Mitchell St Bendigo 3550

The impact

Over thousands of years Aboriginal people maintained a sustainable way of life.

⚠ Risk assessment

Ask students to present their designs of experiments and activities for "Risk assessment". Instruct students about modifications, provide appropriate instruction, safety equipment and supervision. When necessary do the experiment or activity as a teacher demonstration or abandon it altogether.

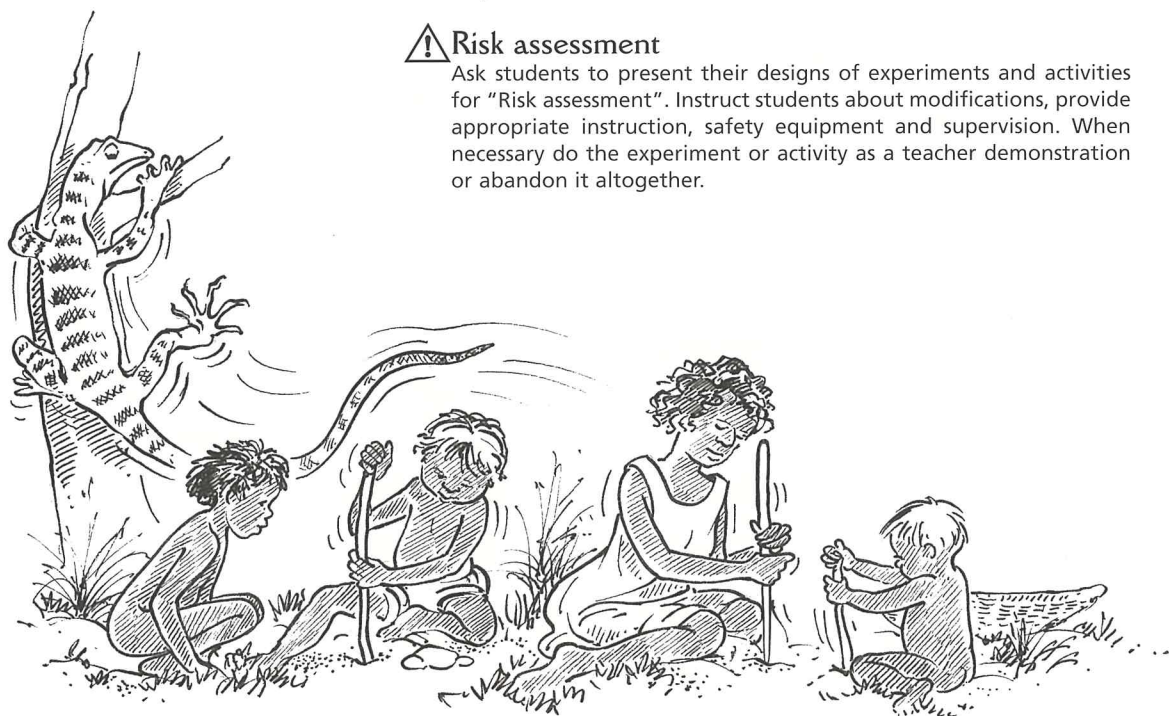

Bush Living



The challenge

Students can investigate Aboriginal bush food by completing a challenge:

1. Visit an Aboriginal Cultural Centre and arrange a talk or demonstration about bush foods or ask a speaker from an indigenous nursery to show students examples of native food plants.
2. Research which native plants were collected by Aboriginal people in the local area. What animals were hunted? Which animals remain?
3. Collect the seeds of native grasses and bushes as well as introduced grasses and bushes. Use a range of tools to try and grind it into flour.
4. Obtain some samples of bush food and test it for vitamin C, starch, protein and fats.
5. As a class use a variety of methods available to Aboriginal people to cook fish or yabbies and determine the most suitable method.
6. Create an effective digging stick for digging up tubers. Design and conduct a safe experiment to test the strength of the stick so it does not crack when it is bent. What technique is most suitable for using the digging stick?
7. Debate whether indigenous people should be allowed to hunt and harvest all wildlife. Are the cultural rules and laws developed by indigenous people over thousands of years good enough to protect endangered species?

Extra information

Gather grass seeds or any other large seeds that can be found in the school ground. Use a large river pebble on a hard surface or a mortar and pestle to grind up seeds. It may be necessary to separate chaff and seed coatings from the flour. Students will realise how difficult it is to make flour from seed.

Reuse

The science

To be able to design and build the things needed in the bush and rural areas, the properties of the available materials need to be understood. Often the most available manufactured materials are scraps and waste.

Lots to do to reduce waste at school: www.gould.edu.au

The impact

When resources are difficult to obtain or too costly, it makes sense to fully utilise the resources available. By having an understanding of the properties of various materials, people in the bush can take a product and reuse it for another useful purpose. This conserves resources and generates less waste.

Few rural properties have weekly waste disposal services going past their gate. Rural people have found practical ways to reuse their waste. Excess food is fed to chickens, paper is burnt in a fire or composted and the few bottles and tin cans may be placed on a small farm tip or into areas damaged by erosion to reduce its impact. Old timbers, car and tractor parts are stored for future use. Many of Australia's vintage cars and trucks are restored farming vehicles. There are still many restored and operating steam driven farm machines because they were not thrown out, but kept to be reused in the future.

The challenge

Students can investigate the opportunities for reusing resources by completing a challenge:

1. Photograph and document ways people reuse materials in the bush and rural areas.
2. Show how five items in a student's bedroom could be reused in the bush or on a farm. Present results as an advertising brochure.
3. Imagine how the furniture in the classroom could be used to make a chicken run, pig pen etc. and draw a design.
4. Reuse packaging materials or other goods no longer required and put them to a new use. Identify suitable applications for different materials and make things, e.g. use a stack of old tyres filled with soil to make a potato patch.
5. Design a ten-step plan to minimise waste at home. Verbally present the ideas to the class.

Extra information

Look around the classroom and find as many opportunities as possible to reuse materials for new applications. Some items are less obvious. Hold a competition for the most imaginative application for reusing.

Bush Living

Mining

The science

Geologists conduct surveys to locate minerals and ores. The minerals and ores need to be in high enough concentration to be economical to extract. Very valuable metals like gold can be mined in low concentrations. Iron ore is extracted and transported in weights of hundreds of tonnes and needs to be highly concentrated.

The most commonly mined materials in Australia are:

Aluminium –	metal (Al) derived from bauxite
Coal –	mostly carbon (C) derived from fossilised plants
Copper –	metal (Cu) derived from many ores including chalcopyrite (CuFeS_2)
Diamond –	special form of carbon (C)
Gold –	found as a metal (Au)
Iron –	metal (Fe) derived from a variety of iron oxide minerals, e.g. hematite (Fe_2O_3)
Lead –	metal (Pb) mostly derived from the mineral galena (PbS)
Magnesium –	metal (Mg) derived from the mineral Magnesite (MgCO_3)
Mineral Sands –	are heavy minerals and include ilmenite (FeTiO_3), zircon (ZrSiO_4) and rutile (TiO_2)
Nickel –	metal (Ni) derived from the sulphide mineral pentlandite ($\text{Fe}_9\text{Ni}_9\text{S}_8$)
Silver –	metal (Ag) derived from various minerals including tetrahedrite ($\text{CuFeZnAg}_{12}\text{Sb}_4\text{S}_{13}$)
Tin –	metal (Sn) derived from the mineral Cassiterite (SnO_2)
Uranium –	metal (U) derived from a variety of minerals including uraninite (UO_2)
Zinc –	metal (Zn) derived from a variety of minerals including sphalerite (ZnFeS)

Information and educational activities at:

www.minerals.org.au and www.min.com.au and www.vicmins.com.au

Reference: *Environmental Management in the Australian Minerals and Energy Industries* 1996, Published UNSW Press.

The impact

Before a major mining operation is approved, extensive environmental impact statements are prepared. Where applicable, negotiations are completed with the relevant Indigenous people and any local interest groups. The mining company must take responsibility for all aspects of potential environmental impact. The mining site is restored as the mining operation is completed.

The challenge

Students can investigate various aspects of mining by completing a challenge:

1. Describe the operation of a local mine.
2. Prepare a flow chart to illustrate the operation of a smelter.
3. Collect and analyse newspaper articles about Indigenous issues related to mining. Compile and present Indigenous views for and against mining.
4. Simulate the problems of operating a mining site by extracting the chocolate chips from a chocolate chip biscuit and restoring the biscuit.
5. As a class discuss and decide who should take responsibility for reducing greenhouse emissions, the general population, government, industry, western world only and/or the entire world?
6. Debate the topic "Mining is essential for humanity to survive".

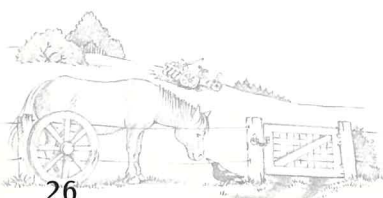
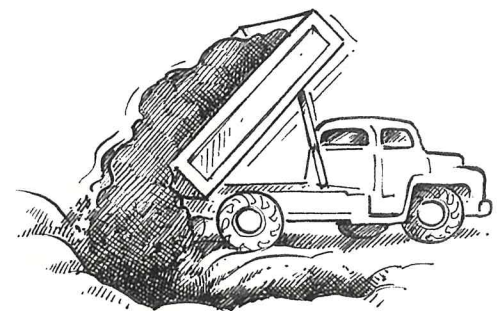
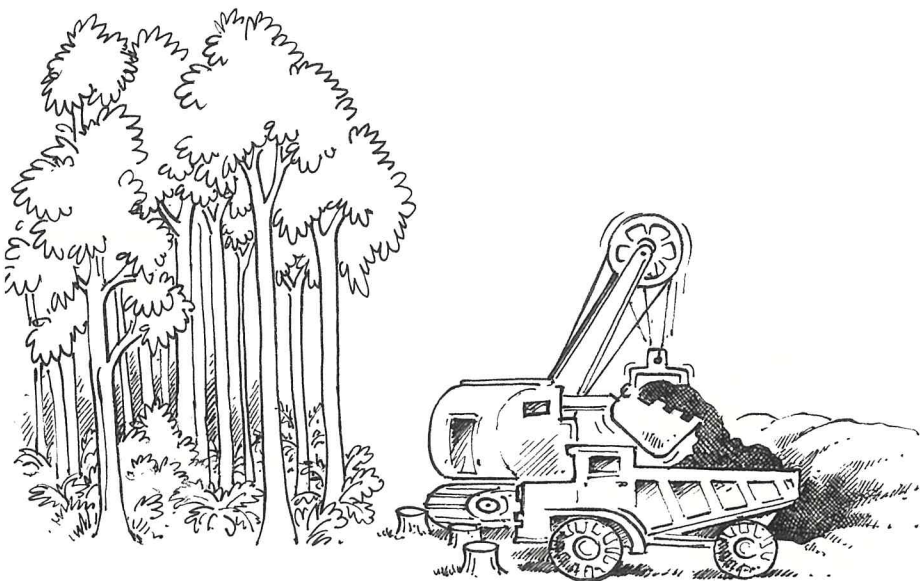

Bush Living

Bush archaeology and things of old

The science

Many techniques are used to date objects made by people. Aboriginal artifacts are commonly dated if they are associated with charcoal and other carbon materials. Carbon dating involves finding out the ratio of the carbon isotope C_{14} to normal carbon C_{12} in charcoal and other remnant materials. The isotope C_{14} is created in the upper atmosphere. Plants take up carbon in the form of CO_2 . Once the plant dies, it can no longer absorb CO_2 . From that moment on the ratio of C_{12} to C_{14} in dead plants changes as the C_{14} slowly decays. As C_{14} decays at a known rate, scientists have a time clock that can be measured using scientific equipment like an Accelerator Mass Spectrometry. Carbon dating is useful from a few hundred years to up to 50,000 years. Carbon dating is of little use for artifacts with no carbon or that are only 100 years old. Glass, rock and pottery don't contain carbon and can't be dated using this method.

For sites that may only be 100 years old, examining material like pottery and glass and finding out when they were produced will be the most helpful way to determine the age of the site. On a rubbish pile used over many years the material will be in layers. The basic principles in aging layers of materials are:

- youngest material is the top layer
- oldest material is the bottom layer
- the youngest date that can be determined for any layer from the artifacts will be closest to the date of dumping.

Weathering and decay of materials will give some clues, but there are many variables between sites, so one site can't be easily compared with another location.

Interactive farm dig online: www.kidsdigreed.com

Archaeology of old farms:

www.reedfarmstead.com and www.kshs.org/perspect/martinfm.htm

More ideas about archaeology activities:

<http://edsitement.neh.gov/lessonplans/archaeology.html>

Check out some medieval archaeology: www.lothene.demon.co.uk

The impact

Preserving history whether it is 40,000 years old or 100 years old can be very important. Experimenting with techniques in archaeology is great on an old farm rubbish dump. However any site that contains materials, artwork etc. from Indigenous people should be respected, protected and not disturbed.

The challenge

Students can investigate historical artifacts by completing a challenge:

1. Describe what might be found and not found at an Aboriginal site.
2. From a display of old materials and objects, describe what the items may have been used for.
3. Examine a display of old materials, inspect a range of their characteristics and construct a timeline. (Which characteristics are most useful for dating?)
4. From observations of a number of materials from the same site, explain how each type of material weathers, decomposes, breaks down or survives over time.
5. Bury a range of materials in the school ground. After two months examine and describe what has become of the remains.
6. With appropriate safety precautions do a dig on an old farm tip. Identify and catalogue the items, their use, their condition and the materials they are made from.
7. Imagine scientists in a thousand years time. What would they infer when investigating a collection of kitchen utensils?
8. Imagine what an Aboriginal archeological site would contain and construct it with imitation artifacts in the school ground.
9. Prepare a set of guidelines concerning how an historical site should be protected.

Extra information

Useful information that should be recorded for an artifact include:

- Exact location and level the artifact was acquired (photograph of the artifact in position is essential).
- Physical qualities of the artifact.
- Any special qualities of the artifact.
- How the artifact may have been used.
- What can be interpreted from the artifact.

Divide the class into at least two groups. Each group collects a range of items used on a daily basis and buries them in separate garden plots. After three months, each group excavates the plot of another group and attempts to identify the items.



Bush Ecology

Introduction to Bush Ecology

The plants and animals of Australia have largely evolved in isolation from the rest of the world. Some of these organisms like the eucalypts and acacias have diversified into extraordinary large and complex groups. Some animals like the platypus, an egg laying mammal, are unique to Australia. One of the platypus's amazing adaptations is its ability to detect using its bill, small electrical currents generated by the muscles of other animals. This enables them to find food at the bottom of dark pools.

Australian terrestrial ecosystems present very different challenges for the survival of organisms living in them. Seed harvesting ants in arid Australia fill the niche occupied by rodents in similar ecosystems in other parts of the world. In dry forest and bushland ecosystems, ants and termites fill the niche earthworms occupy elsewhere. Food chains and food webs constructed from these, therefore, include quite different organisms. Australia's native

carnivorous mammals tend to be relatively small, many about the size of rats. Wetland birds are often nomadic, moving to escape unsuitable conditions and take advantage of more favourable conditions or floods elsewhere. Hundreds of species of insects and other invertebrates depend on eucalypts for food and shelter. These insects are in turn a major source of food for many native birds and mammals.

For more activities to extend this section see The National Science Week 2001 Resource Book, *Exploring Biodiversity* published by ASTA, order by Fax: (02) 6282 9477 or email asta@asta.edu.au

The themes:

Fire	Yabbies
Different environments	Endangered species
Ponds, wetlands and waterways	Bring back the bush
Termites	

Fire

The science

Most of Australia's plants in dry forests, woodlands, grasslands and semiarid areas are adapted to surviving wildfires. The adaptations to survive a fire seem to be endless. Some plants can withstand fire, while others have a variety of ways to regenerate from seed. The fire in any particular patch of ground only lasts for seconds or at most a few minutes. Eucalypts after fire grow epicormic shoots from buds protected under the bark of branches and the trunk. If partially destroyed, eucalypts can also grow new shoots from the lignotuber at the base of the tree and they also release large quantities of seed.

The intensity of a fire and its ability to spread depends on a number of variables. The factors that make a fire more intense include:

- A large amount of flammable material with low moisture content.
- Large quantities of fine fuel, i.e. material less than 6 mm thick burns very rapidly.
- The volatile oils in leaves that provide eucalypts with their characteristic smell contributes to a fire's intensity.
- A large amount of heat generated when the fuel is burnt.
- High winds that feed the flames with oxygen and spread the fire and may also create spot fires.
- Low humidity in the air and a hot day.
- Steep topography that enables a fire to race up hills.
- Grass fires are just as intense and deadly as bushfires in extreme weather conditions.

For details on the ecology of bushfires:

<http://online.anu.edu.au/Forestry/fire/firenet.html>

Reference: Barlow, Alex *Aboriginal Technology, Fire* 1994 Published Macmillan Education Australia.

The impact

Scientists have a lot to learn about the impact of different kinds of fires on the Australian environment. Are fires more frequent since white settlement and if so, what has been the impact? Do regular control burns change the ecology of an area? Now that the Aboriginal people are no longer managing the land with fire, is it having an impact? How can the biodiversity of the bush be protected as well as protecting people from fire?

⚠ Risk assessment

Ask students to present their designs of experiments and activities for "Risk assessment". Instruct students about modifications, provide appropriate instruction, safety equipment and supervision. When necessary do the experiment or activity as a teacher demonstration or abandon it altogether.

The challenge

Students can investigate the effects of fire on the ecology of the bush by completing a challenge:

1. Find out about some of the past fire disasters.
2. When is the local area most prone to fire? What is done to reduce the risks?
3. Obtain a range of native plant seedpods. Place half into a hot oven for half an hour. After a week compare the heated seedpods with the control.
4. Age trees, tree ferns, or grass trees by looking at their fire scars and new growth.
5. Research a plant that is adapted to survive fire and explain its adaptations.
6. Identify changes to present bush environments due to changes in the number of bush fires. Find old photographs, paintings and explorers journals to find out what the bush was like.
7. Write a TV show about Aborigines using fire to manage the land.
8. Prepare an action plan to prepare a home or school in the event of a bushfire.
9. Prepare a case for or against control burning.

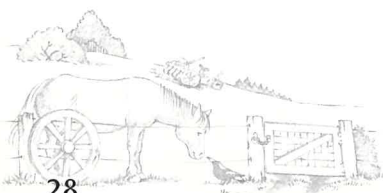

Bush Ecology



Extra information

Most areas of bush will have had a fire move through them in the past 50 years. These are some things to observe that will help date the last fire:

- Eucalypts that have many small branches and leaves growing from their trunk may have been burnt in the past two years.
- Very dense thickets of eucalypt saplings may indicate a fire in the past five years.
- The presence of many understorey wattles or tea-trees indicates a fire less than 20 years old.
- Xanthorhizas or grass trees grow 1 to 2 cm per year. Measure the end of the trunk that is not fire scarred.
- Cycads are palm like plants which have cones and are related to pine trees. Look for fire scarring on the trunk. They grow about 1 to 2 cm per year.
- Inspect fire scarring on eucalypts where the bark has been destroyed and has exposed the wood. The growth and increase in thickness of most trunks will be between about 1 mm and 3 mm per year. Look at the live bark at the side of the scar, and measure the thickness and estimate the number of years.

Different environments

The science

Scientists in Australia have identified 85 terrestrial bioregions as part of the Interim Biogeographic Regionalisation for Australia research. The purpose of developing maps of bioregions is to ascertain whether enough reserves have been established to protect Australia's biodiversity. Climate, geology, topography and biodiversity are taken into account to identify cohesive regions. The information gathered then enables scientists to identify conservation priorities for each bioregion.

At a much smaller scale, in a single locality, there are very different microenvironments. The soil, under a rock, the shade, the open sun, a tree trunk, a tree canopy etc. can each have a different microenvironment. The temperature, humidity, air movement, light intensity etc. can all be very different for each microenvironment.

Websites on Australian bioregions:

www.ea.gov.au/parks/nrs/libraimcr/libra_95/index.html and

www.nlwra.gov.au/atlas/

What to plant in the local bioregion to attract wildlife:

www.floraforfauna.com.au

Reference *Exploring Biodiversity* published by ASTA, order by Fax: (02) 6282 9477 or email asta@asta.edu.au

The impact

Many sensitive environments can't cope with human activities and development. The size of many habitats are shrinking as land is cleared for grazing etc. In particular, in developed and farmed areas it is important to identify the vulnerable environments and species so measures can be taken to protect them. Often the impact of humans on the environment is not recognised as the environment appears to look fine, e.g. woodland ecology is more than just grass and trees.

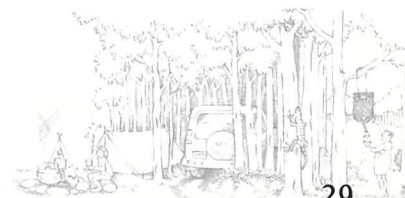

Bush Ecology

⚠ Risk assessment

Ask students to present their designs of experiments and activities for "Risk assessment". Instruct students about modifications, provide appropriate instruction, safety equipment and supervision. When necessary do the experiment or activity as a teacher demonstration or abandon it altogether.

The challenge

Students can investigate different environments by completing a challenge:

1. Use the Internet to find out which Australian bioregion students live in.
2. Use a range of physical and biological measurements to identify different microenvironments in the school ground. Present the findings using maps and tables.
3. Identify the major natural environments of the local area. Find out which species are most conspicuous.
4. Using PET bottles create a range of environments for one species of potted plant to live in and identify the ideal conditions.
5. Investigate and predict which local habitats are at greatest risk. Explain why they are at risk.
6. Create a priority list of habitat conservation actions required for the local area.

Extra information

Go to the website: www.nlwra.gov.au/atlas/

You will find the following topics:

Agriculture
Coast
Land
People
Rangelands
Vegetation and biodiversity
Water

Explore any of these topics and find out how the environments vary throughout Australia.

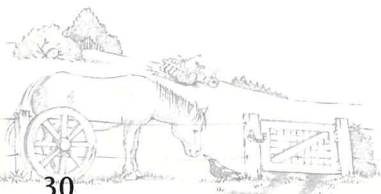
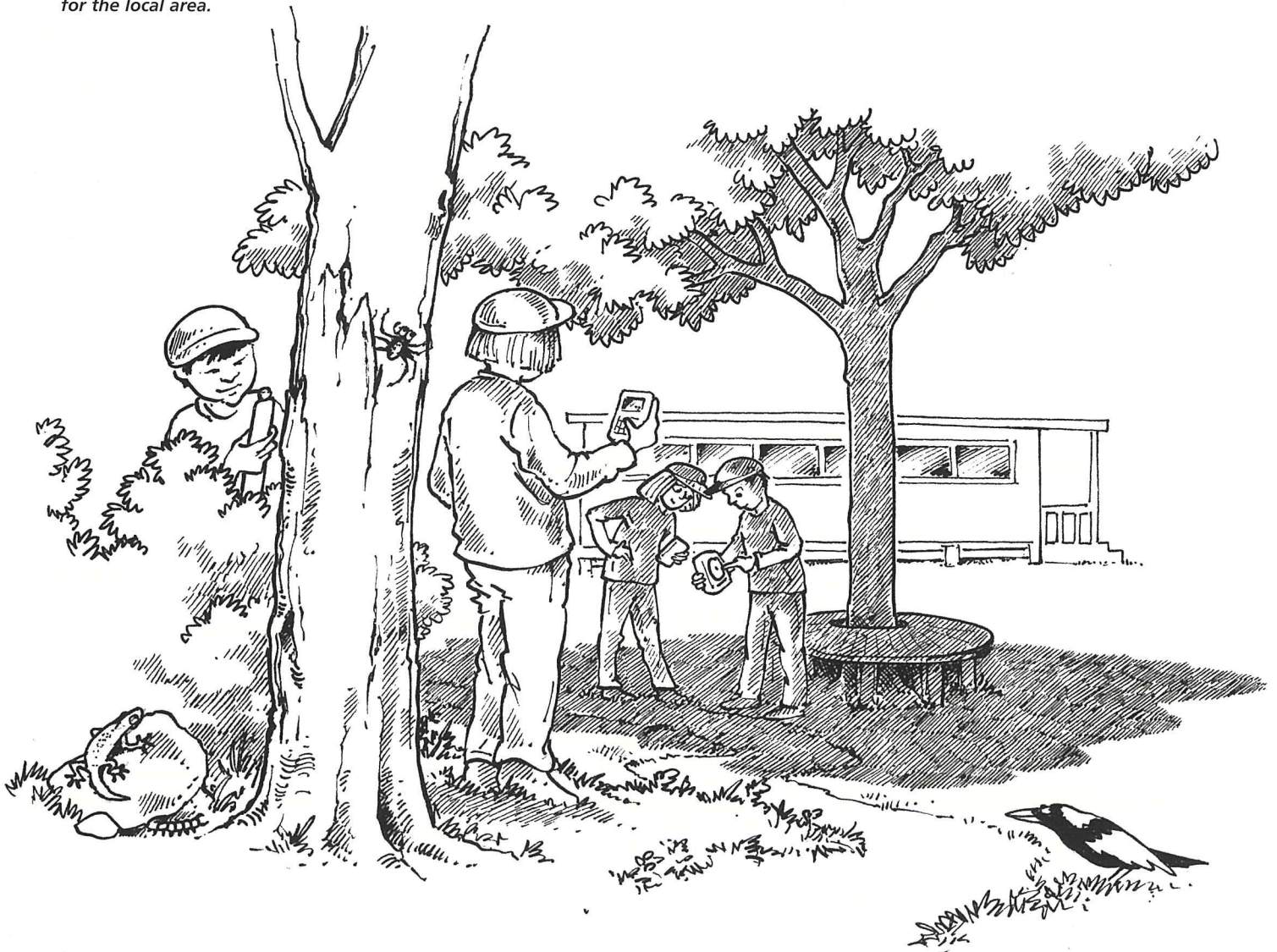

Bush Ecology

Ponds, wetlands and waterways

The science

There are many different kinds of wetland habitat. Swamps, billabongs, lakes and farm dams have still water with many small active swimming animals. Rivers and streams have flowing water and only a few strong animals swim, the rest hold onto rocks or plants or burrow into the river bottom. There are two primary food sources in waterways; plants (macro and microscopic) and detritus. Bacteria and fungus break down waste and dead organic material. The bacteria, fungus and organic material form detritus that is consumed by many aquatic animals. Many small invertebrates specialise in filtering bacteria from the water.

Inland waterways are important habitats for a wide variety of organisms. The waterways can be temporary or permanent, although in time of drought even large rivers become almost dry. Because expansive tracts of Australia are flat, vast floods occur. Rains can flood plains for many hundreds of kilometres.

Animals and plants that have evolved over millions of years with these fluctuations as part of their natural environment are well adapted to survive them. Many wetland birds are nomadic and seem to have little trouble locating large floods anywhere in Australia. Many small animals, particularly crustaceans have very quick life cycles and at their conclusion lay a large number of hardy dormant eggs that will remain in the dried crusty mud ready for the next flood.

While many wetlands have been drained, polluted or much of the water has been diverted for the use of people, a new type of wetland has been created, the farm dam. Farm dams are becoming important habitats for rural wildlife.

These are some of the many good sites to learn about wetlands and fresh water ecology:

www.waterwatch.org.au and www.mdbc.gov.au and www.streetonps.vic.edu.au/enviro/gc_1.htm

References: Gould League publications: *Wetlands Wildlife*, *Freshwater Invertebrate Key* and *Australian Guide to Pondlife*.

The impact

Wetlands at particular times of the year can support a multitude of wildlife. In the past, large concentrations of Aboriginal people lived in the most fertile areas and met along the waterways for ceremonial purposes. Many inland towns are built along the few rivers. The rivers provided water and transport.

However, there is a lot of pressure on Australia's wetland habitats that include:

- Many wetlands have been drained.
- A large percentage of runoff is diverted for the use of people.
- Many polluting substances are flushed into waterways. This includes, insecticides, herbicides, fertiliser, oil, human sewage, dog droppings, other animal manure and litter.
- Cattle, sheep and feral animals trample vegetation while feeding and drinking along waterways. They wade into the water stirring up mud. Their activity can change the composition of vegetation often favouring introduced weeds, e.g. water buffalo activity favours *Mimosa pigra* growth.
- The numbers of floods have been reduced due to large storage dams and the controlling of water flow.



⚠ Risk assessment

Ask students to present their designs of experiments and activities for "Risk assessment". Instruct students about modifications, provide appropriate instruction, safety equipment and supervision. When necessary do the experiment or activity as a teacher demonstration or abandon it altogether.

The challenge

Students can investigate freshwater habitat by completing a challenge:

1. Describe what is required to create a healthy pond.
2. Describe how a range of freshwater creatures move in the water.
3. Examine a wide range of stagnant pools and even untreated swimming pools and find out what lives in them. Safety: Don't inspect polluted water.
4. Find and identify creatures living in a pond, stream, lake or farm dam.
5. Identify the animals and plants that emerge when mud from a pond is placed into water.
6. Examine the biodiversity of a number of waterways and identify the criterion that produce the most biodiversity.

Extra information

To survey freshwater life, students will need material to identify organisms, a fine meshed net and white plastic sample tray. The net can be made from an old pair of pantyhose and coat hanger. The white tray can be an icecream container. Rinse the sample from the net into 1 cm of clear water in the bottom of the tray and watch for moving organisms. More organisms can be observed under both low and high-powered microscopes.



Bush Ecology

Termites

The science

Earthworms, ants and termites are some of the invertebrates responsible for recycling leaf litter and other plant materials back into the soil as humus. Earthworms can only survive in those areas with damp soil and quickly disappear in more inhospitable terrain. Ants and termites are the major "soil engineers" in most of Australia.

Termites live in colonies that are founded by a single reproductive pair. Only the reproductive cast has eyes and wings and they reproduce a massive family of related insects. The blind workers consist of the bulk of the colony. Workers find food, dig tunnels and repair the nest. They feed the larvae, nymphs, soldiers and the reproductive termites. The soldiers have armoured fighting jaws and defend the colony from a variety of predators including ants, centipedes etc. The reproductive female can lay thousands of eggs each day. Colonies can survive for several decades. Only a few species make their nest above ground; most are either underground or within timber.

Termites eat cellulose, e.g. wood is mainly cellulose. Protozoa in the termite's gut breaks down the cellulose. Some species of termites feed cellulose to their underground crops of fungi. This fungi is the main source of their food. A single north Australian termite mound, colony consumes as much biomass as a large cow.

Some details about termite ecology:

www.utoronto.ca/forest/termite/termite.htm

Controlling termites in the USA:

www.doityourselftermitecontrol.com

www.environment.act.gov.au/general/yourenvironmenthwp/termites.html

The impact

Wooden structures are a potential food source for termites thus termites are a significant pest to people. They are worse in tropical zones. At the same time, termites play a significant role in returning nutrients back into the soil.

⚠ Risk assessment

Ask students to present their designs of experiments and activities for "Risk assessment". Instruct students about modifications, provide appropriate instruction, safety equipment and supervision. When necessary do the experiment or activity as a teacher demonstration or abandon it altogether.

The challenge

Students can investigate termites by completing a challenge:

1. Use resources, e.g. books, journals, Internet etc. to find out why termites in some locations are pests.
2. Use resources to find out how the social organisation of termites helps in their survival.
3. Catch some termites from the local environment and start a captive termite colony.
4. Squash a termite and inspect its internal organs. Predict the function of the organs. Use a high-powered microscope to inspect the protozoa in the gut.
5. Role-play a termite moving in its tunnels. Find out what it would be like to live in a dark colony. Rearrange the furniture and make the classroom into a termite maze for blindfolded students to crawl through. Which senses did students use?

Extra information

To sample termites in the local area, place a complete new toilet roll into a tin. If available push a thick stick into the centre of the toilet roll. Invert the tin and toilet roll and place on the ground where termites might live. Inspect every two weeks.

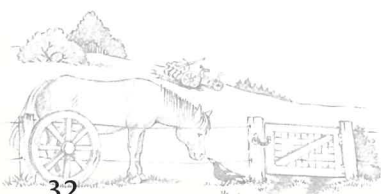
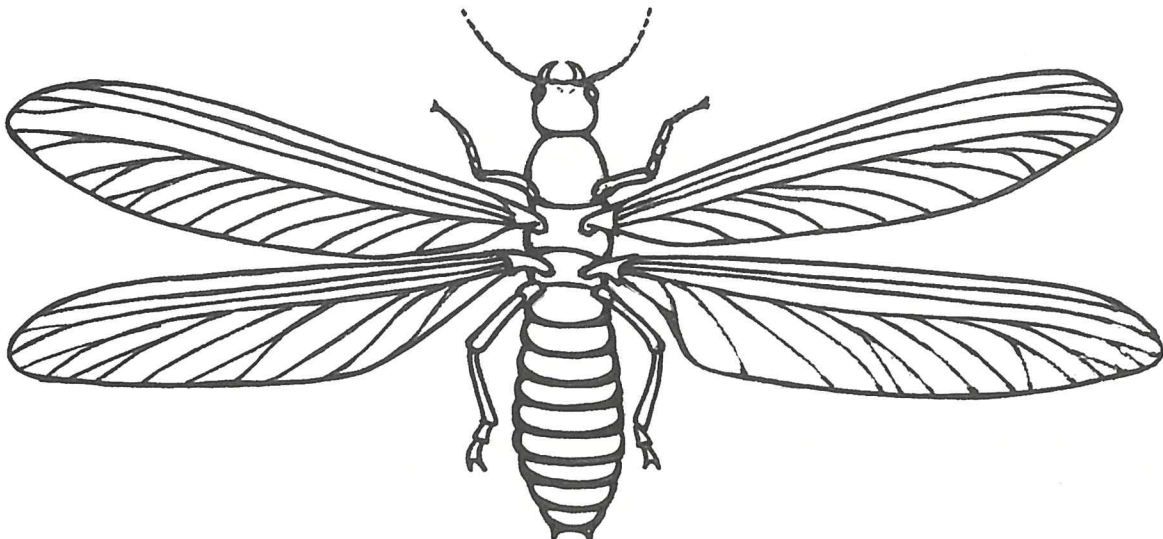

Bush Ecology

Yabbies

The science

Yabby is a word derived from one of the many Aboriginal languages and refers to the common freshwater crayfish. In Western Australia the most common crayfish is the marron. The most familiar species of yabby, *Cherax destructor*, is most common at the bottom of still waters of southeastern Australia. They prefer to hide under submerged logs, but also bury themselves in the mud where they can survive if their habitat dries up. They are capable of moving overland to find new bodies of water. Eggs are attached to the swimmerets along the abdomen. Once young hatch they stay with the mother for a short period.

Most of a yabby's diet comprises of rotting plant material that has been washed into its habitat. The powerful claws are mostly used for protection and challenging and fighting other yabbies. As yabbies have a general diet, they can be a substantial proportion of the biomass of many waterways and therefore a significant source of food for many animals.

Some yabby and marron farming sites:

www.wa.gov.au/westfish/aqua/broc/aquainfo/aqinfo01a.html and

www.anprod.csiro.au/research/purvis/yabbies.html and

www.yabbies.au.com/

The impact

To children, yabbies are an intriguing animal to catch using bait on a piece of string or in the foot of a stocking. They have been an economic problem for some farmers who have their dams or irrigation ditches damaged by burrowing yabbies. In more recent years yabbies and marron have become an important commercial product with large export markets. The commercial use of yabbies is expanding and will become a larger source of income for people in rural Australia. Due to human activity some species are endangered. Some species are protected.

⚠ Risk assessment

Ask students to present their designs of experiments and activities for "Risk assessment". Instruct students about modifications, provide appropriate instruction, safety equipment and supervision. When necessary do the experiment or activity as a teacher demonstration or abandon it altogether.

The challenge

Students can investigate yabbies by completing a challenge:

1. Make a facts chart about yabbies.
2. From a drawing of a yabby, label its internal and external features.
3. Look at a live specimen and find out how it moves.
4. Examine and describe the behaviour of yabbies when they are feeding, if there is a threat, in the presence of other yabbies, when hiding places are introduced into the tank etc.
5. Invent techniques for catching yabbies on a farm dam. (First make sure yabbies are present.)
6. Create an appropriate artificial environment and breed yabbies. (A permit is required in WA.)
7. Assess whether yabbies are regarded as a pest in the local area.

Extra information

Some States and Territories may have regulations that require people to hold a special license if they wish to keep yabbies. Check local regulations before setting up yabby experiments. While meat bait seems to be good for catching yabbies, grated carrot seems to be the best way to feed them and keep their water clean. Yabbies are capable of catapulting their way out of an aquarium so it is better to have a lid on it.

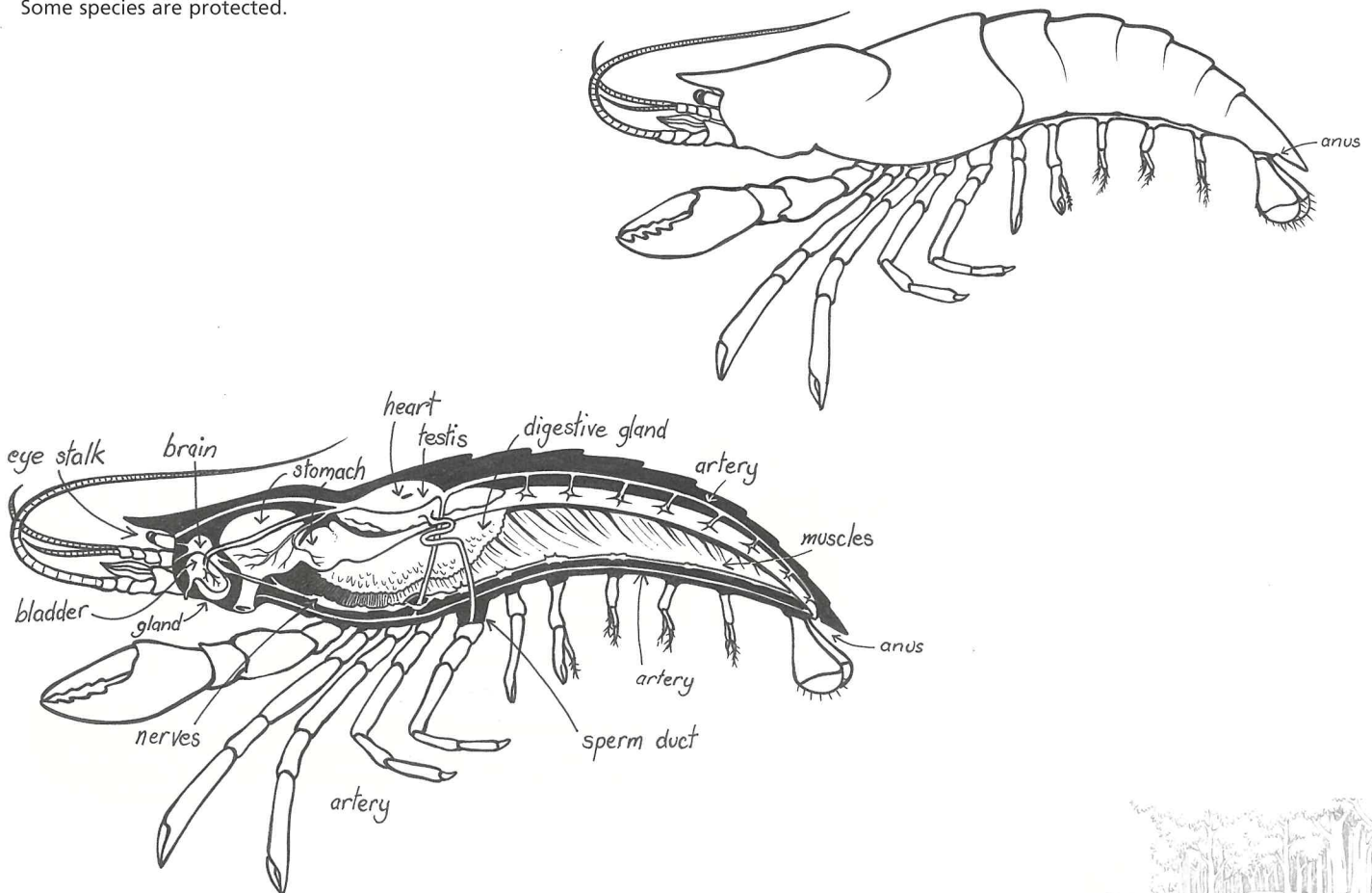

Bush Ecology

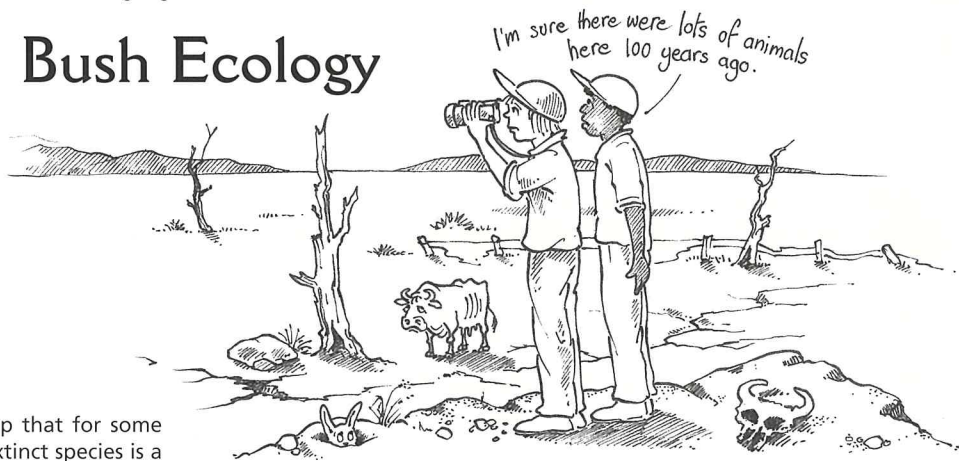

Endangered species

The science

An endangered species is an animal or plant group that for some reason has a real chance of becoming extinct. An extinct species is a group of plants or animals that no longer exist. Scientists recognise some species as being endangered for the following reasons:

- It was once common, but now it is rare.
- The habitat the organism is living in is threatened.
- The animal has always been rare, but a small disaster could tip the balance towards extinction.
- The numbers are progressively decreasing over its range, i.e. the population is less dense.
- The distribution has decreased.
- The organism's habitat is very fragmented.
- The organism is being harvested by people in a non-sustainable way.

Scientists help to save endangered species by:

- Doing surveys of populations and finding out which organisms are endangered.
- Conducting research to identify causes for the problems.
- Designing experiments to find ways to protect the organisms.
- Identifying and documenting strategies to save the organism.
- Implementing, monitoring and improving conservation programs to save organisms
- Captive breeding programs that release animals into appropriate habitat.

Whip around Australia's endangered species:

SA www.esl.com.au

WA www.calm.wa.gov.au

Vic www.zoo.org.au

Canberra www.ea.gov.au/biodiversity

Tas www.parks.tas.gov.au/thrssp.html

Queensland www.env.qld.gov.au/environment/plant/endangered/

And these international organisations:

www.wspa.org.au and www.wwf.org.au

Reference: *Exploring Biodiversity* published by ASTA, order by Fax: (02) 6282 9477 or email asta@asta.edu.au
Endangered Species Kit published by the Gould League, 1996
Endangered! – 10 Playscripts and Drama Springboards by Jill Morris and Lynne Muir, Published by Greater Glider

The impact:

In many Australian regions since European settlement, the impact of agricultural practices, land management, feral species, weeds disease etc. has been dramatic. Of all the wildlife affected, mammals living in Australia's woodlands, grasslands and semiarid regions have the largest number of endangered and extinct species. In these same areas many small species of ground-dwelling plants have also been affected. The changes to the plants and animals have occurred for the following reasons:

- Introduced feral animals like rabbits have consumed most of the available food and denuded the landscape.
- Introduced predators like foxes and cats have hunted the wildlife.
- Agricultural practices like ploughing the ground and the use of fertiliser, destroys grasslands.
- Introduced weeds are invading natural areas and competing with indigenous plants.
- Some areas are overgrazed leaving little or no cover for ground animals.
- Large-scale clearing has fragmented some habitats, leaving small dispersed and vulnerable populations.
- Draining of wetland and flood controls have changed these habitats.
- Dozens of other issues such as the removal of timber from the forest floor for firewood are also starting to have an impact.



Risk assessment

Ask students to present their designs of experiments and activities for "Risk assessment". Instruct students about modifications, provide appropriate instruction, safety equipment and supervision. When necessary do the experiment or activity as a teacher demonstration or abandon it altogether.

The challenge

Students can investigate endangered species by completing a challenge:

1. Use the Internet to find out about some of the projects being done in Australia to help endangered species.
2. Complete a project using library references on an endangered animal.
3. Find out why some species of plants or animals have disappeared from the local area.
4. Overlay distribution maps of endangered and extinct Australian animals. What kind of habitats do most endangered and extinct animals come from?
5. Organise a way to be involved in a local conservation project or raise money to help an endangered species.
6. Select the plants and animals in the local area most in need of conservation assistance.
7. Discuss various factors scientist take into account when developing a captive breeding program to increase populations of endangered species.

Extra information

Generate a concept map of:

- what students know about endangered organisms
- why students think some animals have become endangered
- what they believe should be done to protect these organisms.

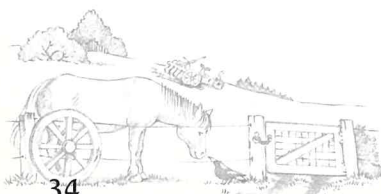

Bush Ecology

Bring back the bush

The science

In some areas of bush the most dramatic way to restore the habitat is to eliminate rabbits and remove introduced grazing animals. In many other areas of bush the greatest threat is weeds. Most are introduced from overseas. Native plants not indigenous to an area can also cause problems. Getting the weeds removed may require pulling weeds by hand, digging with hand tools, using herbicides, introducing biological control measures like insects or even using chainsaws or bulldozers.

Where the bush has been cleared it is possible to grow a new habitat. The area will require preparation that includes the removal of weeds and usually some kind of control of grazing animals. Local nurseries grow indigenous plants using seeds from local species. When planting new habitat most of the plants will be groundcover plants like native grasses. There will only be a few shrubs and even fewer trees.

Organisations restoring the bush:

www.landcareaustralia.com.au and www.greeningaustralia.org.au

Create backyard habitat: www.florafortauna.com.au

Weeds that threaten the Australian environment: www.weeds.org.au

References: *Exploring Biodiversity* published by ASTA, order by Fax: (02) 6282 9477 or email asta@asta.edu.au
Bring Back the Bush Published by the Gould League.

Enviro Smart – An Environmental Resource Program for students in the Middle Years of school, published by Minerals Council of Australia, 2000. Refer to page 19 for more details.

The impact

There is an extensive network of volunteer groups like Landcare organising hundreds of conservation projects. These community groups are involved in the restoration of their local bush environments. Their work is essential in protecting local biodiversity. Schools can also become involved. They can assist community groups in the local environment or adopt a patch of bush to restore and protect.



The challenge

Students can investigate how they can assist in the protection and restoration of the bush by completing a challenge:

1. Write a story about a nasty weed invading the bush.
2. Remove weeds from school grounds.
3. Make a weed collection by preserving and identifying specimens.
4. Make a wildlife habitat in the school.
5. Adopt a patch of bush and help with its management (with references and referrals).
6. Assess how effective conservation measures are at restoring the local bushland and other habitats.

Extra information

If the students would like to become involved in the creation of habitat, they have a number of options:

- They can assist local volunteer groups or parks with various tasks. Find out which groups are active in the area and how students can participate. Ask Landcare for assistance.
- Students and teachers can initiate a bush restoration project in the school ground. Ask Greening Australia what courses they have available to train students, teachers or parents. Use the website www.florafortauna.com.au to design a wildlife patch.
- Adapt a local patch of bush to restore and protect. Get permission from the local land managers. Obtain advice from local expertise such as Landcare groups, local conservationist, local government or park rangers. It may be desirable to ask Greening Australia for some appropriate training.

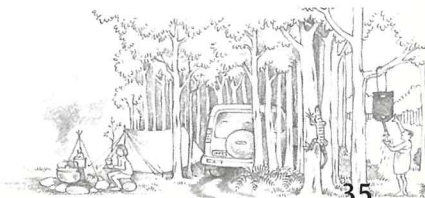
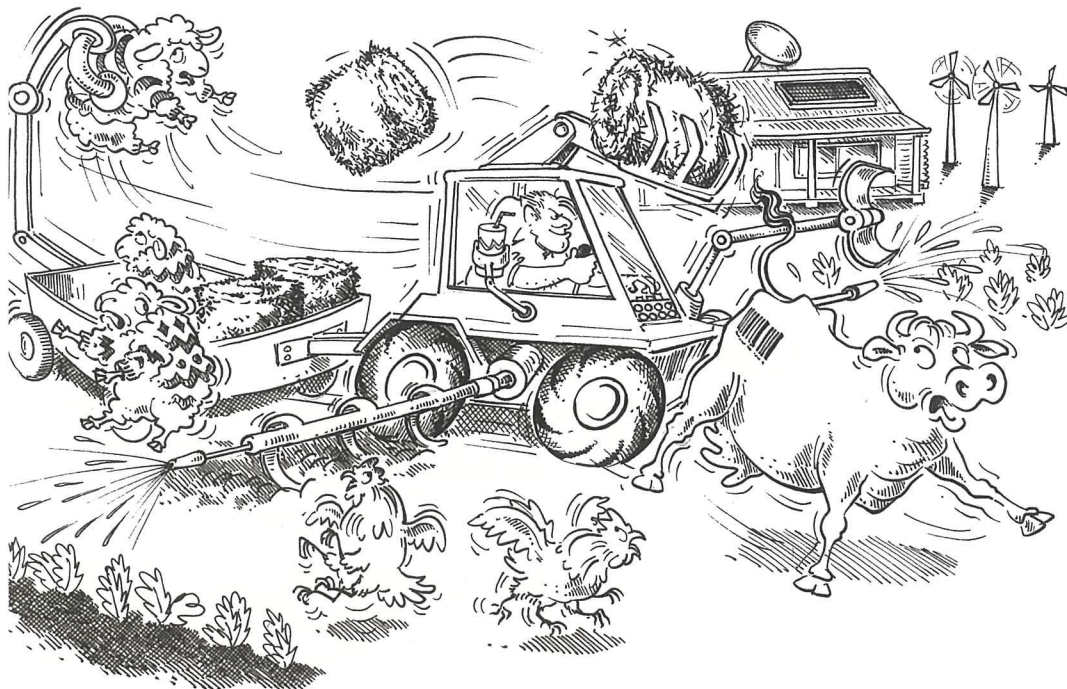

Questionnaire

NATIONAL SCIENCE WEEK 2002 RESOURCE BOOK

Investigating Science in the Bush has been published with sponsorship from the Department of Education, Science and Training. We are asking for your help in gauging the value of the book to teachers. Please take a few minutes to complete and return the questionnaire and be in the draw for a great prize.

Please circle as appropriate.

Did you find this book useful? excellent / very good / satisfactory / poor / of little use

Have you used the National Science Week Resource book in previous years? Yes / No

Was this year's book as useful as last year's book? more / same / less

Which two features of the book were of most use to you?

1.

2.

Which two features of the book were of least use to you?

1.

2.

Was the balance between investigations and activities right? Yes / No

Does the book include an appropriate balance of activities between primary and secondary levels?
Just right / too targeted towards primary / too targeted towards secondary

Are there any changes you would suggest?
.....
.....

Does the book have application in your curriculum beyond National Science Week? Yes / No

National Science Week 2003 will be held in 16-24 August and the topic for schools is Freshwater, to complement the International Year of Freshwater. Please give your suggestions for improvements for future editions of the teachers' resource book.
.....
.....

Fax this questionnaire to (02) 6282 9477 no later than 31 July 2002 to be in the draw for the fabulous prize.

Your name: Your year level:

Your school:

School's address:

School's phone number: School's fax:

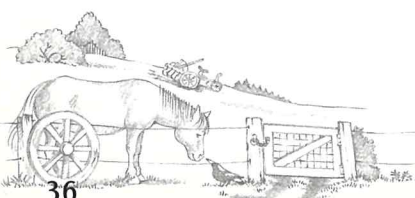

innovated

innovation in education

Innovations in *InnovatED*

In the beginning

In March 2001, IP Australia launched *InnovatED* (www.innovated.gov.au), an exciting, new, interactive, educational resource designed to empower young Australians and foster innovation and creativity in schools. This national initiative has been greeted with enthusiastic support from teachers and schools, and is widely recognised as a valuable educational tool. Now, following its initial success, the program is undergoing a transformation. When completed, the new *InnovatED* will become an even more significant Australian educational resource.

InnovatED is funded by IP Australia, the government agency responsible for patents, trade marks and designs. The initial goal of the project was to develop an educational resource designed for use in years 5–9 that link the concepts of creativity and innovation to Key Learning Areas.

The project consists of

- a teachers' web site – which includes a database of lesson plans, teachers' resources and an online newsletter;
- the students' *Big Ideas Network* web site – with activities, games and other resources; and
- an educational *Big Ideas* CD-ROM game.

The positive response from educators and students is clearly demonstrated

in the 3,000 plus sessions per month that the *InnovatED* web site receives. Also, over 5000 copies of the *Big Ideas* CD ROM game have been requested and distributed to schools. This encouraging response has enabled IP Australia to gather valuable feedback about the project – how it is used in the classroom, how teachers and students have benefited from the project, and how the resource can be improved.

Into the future

Now that the *InnovatED* program has been evaluated, IP Australia is already implementing plans that incorporate feedback we have received, together with the results of the evaluation process, to reshape and refocus the project. The evaluation succeeded in determining how *InnovatED* could become even more accessible to teachers and students.

The improvements to the program include enhancing and streamlining the resources available on the teachers' site as well as an extensive upgrade to the students' *Big Ideas Network* site. There will be a stronger relationship between the *InnovatED* lesson plans and the activities and games on the *Big Ideas Network* web site. Also, *InnovatED* will include interactive elements from *Ippyonline* (www.ippyonline.gov.au), another educational initiative funded by IP Australia.

IP Australia has timed the changes so that the new *InnovatED* will be

completed for 2002, enabling you to access the new resources as you are developing lesson plans for the year.

Pay us a visit

InnovatED is not a static resource, it is designed to be responsive to the everyday needs of Australian teachers and students. Teachers are encouraged to visit the *InnovatED* site, where there is a growing database of quality lesson plans and related material, created specifically for use in Australian schools. When visiting the site, please feel free to contact IP Australia with ideas or suggestions on how the project can be enhanced or adapted to suit your particular needs. IP Australia gratefully acknowledges the input and enthusiastic support that has helped make *InnovatED* an outstanding success, but also recognises that the continued success of *InnovatED* depends on you, the teachers and students who use it. Your input and valued feedback will help shape the future of this unique project and enable it to fulfill its potential as one of Australia's premiere educational resources.

Thinking of lesson plans for 2002?

The key benefits of the *InnovatED* program are:

- free powerful educational resource for teachers;
- inline with Key Learning Areas;
- database of 125 free searchable lesson plans (and growing);
- associated student's educational material; and
- free student's educational game available — *Big Ideas*. A CD-ROM that can be used in the classroom or at home and can be ordered from the *InnovatED* web site.

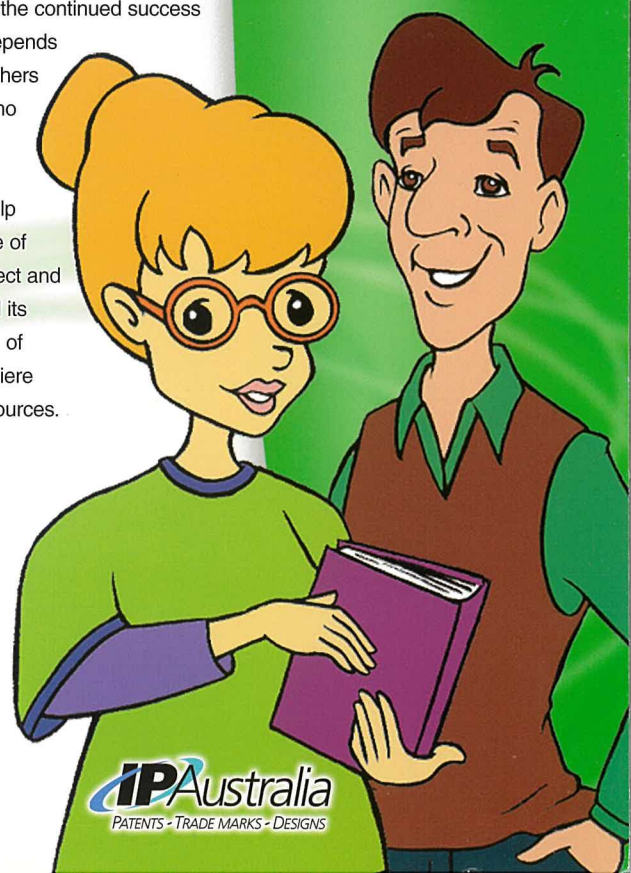

If you would like any further information on the *InnovatED* program, please contact IP Australia on 1800 010 999.

www.innovated.gov.au

IPAustralia
PATENTS - TRADE MARKS - DESIGNS

51st

NATIONAL

Conference of Australian
Science Teachers Association



Problem Solving and the Ethical Dilemma



Saturday 6th to Thursday 11th July 2002 - Wrest Point Hotel Casino

Wrest Point Hotel Casino and Convention Centre:

- 3km from the City
- 5 Star and 4 Star Accommodation
- River View complex
- Fine Restaurants
- Health Club, tennis court or a cool drink and watch the river go by.

Keynote program with a range of quality speakers on

Science

- Seahorse breeding
- Environment, sustainability and economy in mining
- Firearms and forensics
- Controversies
- Southern Ocean and Sub Antarctic research.
- Cutting edge science and real problems and Dilemmas

Science Education

- Our move towards a scientifically literate community
- School reform and the changing culture of science education
- Ethics, strategies and ideas and the teaching of science
- National and international perspectives
- Science education responds to the challenges

For more information and online registration visit www.agsci.utas.edu.au/conasta/

